

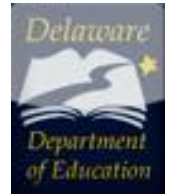

SAFETY FIRST

Safe Instructional Practices in the
Classroom and Laboratory

Safety First: Safe Instructional Practices in the Classroom and Laboratory.



Delaware Department of Education

Dr. Lillian Lowery, Secretary of Education

Mr. Dan Cruce, Deputy Secretary of Education

Teaching and Learning Branch Curriculum, Instruction, & Professional Development Workgroup

Dr. Linda Rogers, Associate Secretary

Ms. Marian Wolak, Director CIPD

Science Education

Ms. Tonyea Mead, Education Associate, Science

Mr. John Moyer, Education Specialist, Science

College & Workforce Readiness Branch Career, Technical, & Title 1 Resources Workgroup

Dr. Amelia Hodges, Associate Secretary

Career & Technical Education

Dr. Dale Derrickson, Education Associate

Technology and Engineering Education

Mr. Michael Fitzgerald, Education Associate

Agricultural Science Education

Dr. Karen Hutchison, Education Associate

Family & Consumer Science Education

Ms. Rita Hovermale, Education Associate

This safety manual is the result of a collaborative effort between the Delaware Department of Education and the Connecticut Department of Education with consultation from Dr. Kenneth Roy, Glastonbury Public Schools.

Adapted from *Connecticut High School Science Safety: Prudent Practices and Regulations*, Copyright 2008, Connecticut State Department of Education. <http://www.ct.gov/sde>. Used by permission.

ACKNOWLEDGEMENTs

Special thanks to Dr. Kenneth Roy, science safety compliance specialist with Glastonbury Public Schools, for his important contributions to this document. Dr. Roy can be reached at royk@glastonburyus.org

Special thanks to the Carolyn Zogby, Edward McGrath, and the Red Clay Consolidated School District for their contributions to the document.

CONTENTS

Section	Subject	Page(s)
	Credits / acknowledgements / & Table of Contents	1-5
I	Science Education Safety	6-7
II	OSHA Laboratory Standard: The Bedrock for High School Safety	8-11
	<i>Delaware's Chemical Safety Plan</i>	10
III	Responsibilities in Laboratory Safety	12-21
	<i>Safety Responsibilities of the Classroom Teacher</i>	13-19
	<i>Safety Responsibilities of the Chemical Safety Officer</i>	19
	<i>Safety Responsibilities of the Administration</i>	20
	<i>Safety Responsibilities of the District Science Supervisor or Specialist</i>	21
IV	Important Definitions in Understanding Laboratory Safety	22-27
V	Basic Principles of Laboratory Safety	28-30
VI	General Laboratory Safety Specifications	31-55
	<i>Environmental Settings & Considerations</i>	32-39
	<i>Prudent Work Practices</i>	39-52
	<i>Personal Protective Equipment (PPE) Requirements</i>	52-54
VII	Physics Laboratory Safety Specifications	56-62
VIII	Chemistry Laboratory Safety Specifications	63-73
IX	Biology Laboratory Safety Specifications	74-82
X	Earth & Space Science Laboratory Safety Specifications	83-86
XI	Technology Education Laboratory Safety Specifications	87-95
XII	Agricultural Science Laboratory Safety Specifications	96-104
XIII	Career & Technical Education Laboratory Safety Specifications	105-114
XV	Family & Consumer Science Education Laboratory Safety Specifications	115-117

Table of Appendices:

Appendix	Description
A	Regulation 885 – <i>Safe Management, Storage, and Disposal of Chemicals in the Delaware Public School System</i>
B	On-Site Compliance Monitoring Checklists
C	List of Known Carcinogens
D	List of Extremely Hazardous Chemicals
E	Approved Chemical Waste Haulers & Contact Information
F	Chemical Storage Color Coding System
G	Storage of Pressurized Liquids and Gases
H	Sample Chemical Inventory Form
I	NFPA Hazard Rating System
J	Labels for Non-Chemical Refrigerators
K	Biohazard Sign



I. SCIENCE EDUCATION SAFETY

I. SCIENCE EDUCATION SAFETY

Education in the 21st century necessitates active, hands-on learning opportunities that require great care and prudent planning. Inquiry and investigation are the hallmarks of effective instruction at all levels and all grades. All laboratory work, whether it occurs with chemicals, with electricity, with living organisms, or in a natural environment, pose some degree of risk. The guidelines set forth in this regulation reflect the accepted “best practice” procedures set forth by national organizations.

Why is there a need for strong safety programs in Delaware’s high schools?

Revolutionary changes are taking place in education as a result of several factors including:

- Renewed emphasis on hands-on, inquiry-based laboratory science fostered by the national and state level standards.
- An emphasis on Science, Technology, Engineering, and Mathematics (STEM) education in Delaware schools.
- Significant changes in student enrollments
- Major building and renovations of school facilities.
- An emphasis on high quality education for all students
- Curriculum and assessment changes resulting from state and federal legislation
- Significant efforts to foster student involvement in early college experience programs such as Advanced Placement and International Baccalaureate.
- Changing demographics of the teaching workforce.

Teachers as licensed professionals are charged with duty or standard of care relative to their students. It is a professional expectation that teachers take all possible actions to help prevent an accident or safety incident from happening. In other words, what would the “reasonably prudent person” do to prevent exposure of students to laboratory hazards? The challenge and responsibility to help make the instructional area (laboratory) a safer place for students is both a professional and legal expectation for the teacher and school administration.

The purpose of this manual on safety is to provide direction, support, and resources for high school teachers and school administrators relative to planning engaging and safe learning opportunities for students based on prudent professional practices and legal safety standards. Whenever possible, information is used from national sources such as the Occupational Safety and Health Administration (OSHA), National Fire Protection Association (NFPA), National Science Teachers Association (NSTA), and the Environmental Protection Agency (EPA).



II. OSHA LABORATORY STANDARD THE BEDROCK FOR HIGH SCHOOL SAFETY

II. OSHA LABORATORY STANDARD THE BEDROCK FOR HIGH SCHOOL SAFETY

OSHA's "Occupational Exposure to Hazardous Chemicals in Laboratories" (29 CFR 1910.1450) or "Laboratory Standard" took effect in 1990. It is a standard performance-based program that provides basic outline requirements for an employer (Board of Education) to assess the hazards in laboratories and write a "chemical hygiene plan" tailored to meet their needs. Included in the Laboratory Standard is the requirement for an employer-appointed chemical hygiene officer. The chemical hygiene officer is to provide technical support in developing and implementing the chemical hygiene plan.

Basic Elements of the OSHA laboratory safety plan

- Standard operating procedures
- Criteria to determine and implement control measures to reduce employee engineering controls, use of personal protective equipment and hygiene practices.
- Requirement that fume hoods and other protective equipment are functioning within specific measures.
- Provisions for employee information and training relative to the laboratory chemical hygiene plan, chemical references and more.
- Circumstances where laboratory operation requires prior approval from the
- Provisions for medical consultation and examinations.
- Hazard identification, including use of material safety data sheets (MSDSs) and use of respirators.
- Required record keeping — record of any measurements taken to monitor any medical consultation and examinations including tests or written opinions by this standard.

A complete list of the Laboratory Standard can be found at the following OSHA website address:
<http://www.osha.gov/SLTC/laboratories/index.html>.

While custodial areas in public schools are subject to OSHA regulations, educational areas are exempt from these regulations for the most part; however, the guidelines are still used as the framework for safety regulations established in Delaware's Title 14 laws and Administrative Codes. Schools may impose guidelines that are stricter than those outlined in Title 14. For example, the Career & Technical Education areas typically self-impose OSHA industry standards on themselves so that students are adequately prepared to work safely in the workplace upon graduation.

Delaware's Chemical Safety Plan

All Delaware public schools shall have a Chemical Safety Plan that outlines specific district or charter school procedures in the area of staff and student chemical safety [Title 14, Regulation 885].

The Chemical Safety Plan shall include at least the following:

1. Identification of at least one Chemical Safety Officer for the district or charter school who shall:
 - a. Act as liaison between teachers, building and administration, and facilities staff regarding Chemical safety issues;
 - i. Maintain the Chemical inventory for the school(s);
 - ii. Approve all Chemical orders by the district or charter school,
 - iii. Maintain a supply of Material Safety Data Sheets (MSDS) for all chemicals in the Chemical inventory;
 - iv. Assist with maintenance requests related to safety equipment; and
 - v. Identify and coordinate disposal of Hazardous Chemical wastes.
2. Standard operating procedures associated with Chemical use, Chemical Storage, Chemical disposal (both Hazardous and Non-hazardous), and the handling of Chemical spills.

The Chemical Safety Officer shall provide the link between district or charter school administration and the classroom teacher for safety matters. Each district or charter school will have a unique way of managing chemical safety, and safety in general, in their school (s). A school district may assign a single person to be the Chemical Safety Officer at the district level or each school may choose to have their own representative. The person may be the science department chairperson, the chemistry teacher, an assistant principal, the science specialist, or the curriculum director. This person will support chemical safety issues in all instructional areas, not just science, and shall be aware of how chemicals are used in other instructional areas such as agriculture education, career and technical education, technology and engineering education, family and consumer science education, art education, and athletics/athletic training courses.

The Chemical Safety Plan may be unique to the school, district, or charter school; however, the mandatory components must be noted in the document. The expectation is that the school district or charter school will outline specific guidelines surrounding the management of chemicals that align to the mandatory components listed in Title 14, Regulation 885. The plan shall address hazardous chemical use (purchasing, inventorying, labeling/identification, use, storage and disposal) and provide training/information for employees working in instructional areas that would expose them and their students to hazardous chemicals. (See also Title 16, Regulation 4456 for employer-employee safety training guidelines).

Additional OSHA standards, interpretations of standards (official letters of interpretation by OSHA) and national consensus standards relative to laboratories can serve as a resource to educators.

These include the following:

American National Standards Institute (ANSI)

- Z358.1. Contains provisions regarding the design, performance, installation, use and maintenance of various types of emergency equipment (showers, eyewashes, drench hoses, etc.). In addition to these provisions, some general considerations apply to all emergency equipment.

American National Standards Institute (ANSI)/ American Industrial Hygiene Association (AIHA)

- Z9.5-2003, Laboratory Ventilation. This authoritative publication is intended for use by employers, architects, occupational and environmental health and safety professionals, and others concerned with the control of exposure to airborne contaminants. The book includes new chapters on performance tests, air cleaning, preventative maintenance and work practices. It also highlights the standard's requirements and offers good practices for laboratories to follow. The book also offers referenced standards and publications, guidance on selecting laboratory stack designs, an audit form for ANSI Z9.5, and a sample table of contents for a laboratory ventilation management plan.

American Society of Heating, Refrigerating and Air-Conditioning Engineers (ASHRAE)

- 110-1995, Method of Testing the Performance of Laboratory Hoods. Specifies a quantitative test procedure for evaluation of a laboratory fume hood. A tracer gas is released at prescribed rates and positions in the hood and monitored in the breathing zone of a mannequin at the face of the hood. Based on the release rate of the tracer gas and average exposure to the mannequin, a performance rating is achieved.

National Fire Protection Association (NFPA)

- 45, Standard on Fire Protection for Laboratories Using Chemicals. Applies to laboratories in which hazardous chemicals are handled or stored.
- 101, Life Safety Code Standard. Applies to all educational settings.

International Code Council (ICC)

- 2003 International Codes. Links to several standards that are applicable to laboratories, particularly the International Fire Code. Topics addressed in this code include fire department access, fire hydrants, automatic sprinkler systems, fire alarm systems, hazardous materials storage and use, and fire-safety requirements for new and existing buildings and premises.



III. RESPONSIBILITIES IN LABORATORY SAFETY

III. RESPONSIBILITIES IN LABORATORY SAFETY

A. Safety Responsibilities of the Classroom Teacher

Classroom teachers must provide a standard of safety in their teaching environments. The Council of State Science Supervisors (CSSS) and other nationally recognized organizations identify three basic duties of the teacher that relate to **laboratory safety**.

Duty of Instruction: adequate instruction before beginning a laboratory activity.

Duty of supervision: adequate supervision of students such that they behave properly and avoid foreseeable dangers.

Duty of maintenance: assurance that the teacher maintains a safe environment and properly functioning equipment for instruction.

1. Duty of Instruction

- a) Safety rules are posted in the classroom in a prominent place.
- b) Science, Technology, Engineering, and several other areas of instruction inherently involve specific safety concerns. All students must be instructed in the proper safety procedures for each course prior to the start of any laboratory activity, especially if those activities involve chemicals.

This instruction must be:

- accurate
- appropriate to setting
- appropriate for the maturity of the audience, and
- current

This must occur at the beginning of each school year and/or the beginning of each semester. Students must acknowledge their instruction of safety issues by signing a **student safety contract**. Teachers should continue to assess understanding of safety rules regularly, and document such instruction. It is considered a good operating practice to also have parents/guardians sign the **student safety contract** as well. Teachers may document that parents have reviewed the safety expectations through return of the signed contract or through direct parent contact (by phone, email, or letter).

(These items are mandatory for compliance to Title 14, Regulation 885)

- c) The teacher must identify and clarify any specific hazards involved with individual activities. This instruction must include:
- proper handling and disposal of materials
 - possible (but realistic) hazards associated with each procedure
 - ways to prevent hazardous situations, and
 - the necessary course of action if a hazardous situation should occur

2. Duty of Supervision

- a) The most effective way to prevent hazards in any classroom is with clear consistent standards of behavior, including consequences for infractions. Misbehavior and horseplay create an unsafe environment for all, and must never be tolerated.
- b) Students must be supervised by a teacher or other authorized personnel at all times. This is particularly important in laboratory situations.
- c) If the teacher is absent from school, laboratory work must not be left as a substitute lesson plan.
- d) Materials for laboratory exercises must be stored securely away from the student areas when not in use.
- e) The level of supervision must be appropriate to the age of the students, the degree of inclusion, and the hazardous nature of the work.
- f) The teacher must ensure that students have adequate workspace and that all areas where students are working are accessible by the teacher.

3. Duty of Maintenance

- a) All chemicals must be properly labeled and prepared fresh. Teachers must follow appropriate procedures for proper use, storage and disposal of all chemicals. (see also Section VI, #17 *Chemical Storage*)
(These items are mandatory for compliance to Title 14, Regulation 885)
- b) Teachers should only prepare sufficient quantities of working solutions of chemicals to complete a given activity. At the end of the activity, surplus quantities of working solutions should be discarded if they will not be used in a reasonable amount of time. Chemicals must never be left out in the classroom overnight.
- c) Teachers must monitor and arrange for necessary maintenance on apparatus used in student instruction. Defective equipment must either be repaired or discarded if repair is impossible.

- d) Teachers and administrators must work together to keep safety equipment functioning properly. Safety equipment (e.g. fire extinguishers, safety showers, etc.) must be inspected regularly and serviced annually or after use. Teachers must file a written report for maintenance, in accordance with district and/or school guidelines, of any defects in the physical environment that might compromise safety directly to the building principal.
- e) Fire extinguishers are to be inspected in each school annually in accordance with district guidelines and guidelines established by state fire code (NFPA regulations). Teachers must communicate with the Chemical Safety Officer, chief custodian and/or principal to be sure all fire extinguishers are identified and inspected.

(Primary Source: *Science and Safety Making the Connection* Council of State Science Supervisors.)

B. The School Safety Program and the Teachers' Responsibilities

1. The Chemical Safety Officer and the school building principal will be the points of contact in the building for all matters relating to safety issues. It is ultimately the responsibility of the school principal to provide a safe educational environment for all students and staff.
2. Laboratory experiments must only occur in locations with adequate space. Students must have 50 square feet per person of work space when working with hazardous chemicals. The amount of space required for a given activity may vary, but will depend on the following factors:
 - The nature of the activity
 - The overall design of the classroom
 - The number, age, and special needs of the students
3. Teachers must advise administrators when there is insufficient space for safe laboratory instruction or when instruction will take place outside of the normal classroom. In addition, the work area must be arranged so that the teacher may circulate around the classroom and supervise students. Compartmentalization (creation of small secluded workspaces) hampers the teacher from supervising students properly and can lead to improper laboratory behavior going undetected.
4. Teachers must report any hazardous or potentially hazardous conditions in writing to the Chemical Safety Officer, head custodian, and the principal immediately. Teachers must retain a copy of the report, and follow up with the progress of the report as needed until correction has been achieved. Until the hazard has been corrected, the teacher must suspend any laboratory work that could pose a danger to others as a result of the hazard.
5. The most effective way to ensure adequate safety practices in the classroom is for safety instruction to occur throughout the year as an integral part of every activity.

6. Teachers must ensure that all safety equipment in the classroom is well maintained and easily accessible. In particular,
 - Desks do not block safety showers or eyewashes.
 - Fume hoods are not be used to store chemicals.
 - Classrooms have immediate access to a class ABC fire extinguisher and a fire blanket. These should be in a location to allow access in 30 steps or within 15 seconds. Teachers should communicate with the chief custodian about the location of all fire extinguishers. If a fire extinguisher is deployed at any time for any reason, the principal and the chief custodian must be notified immediately with all relevant details.
 - Adequate ventilation appropriate for the laboratory exercise must be maintained. Any work that generates hazardous fumes must be performed in a functional fume hood. (See MSDS for the specific chemical for more information)
 - Exits from the room must be easily accessible to all students, especially those with assistive devices (e.g. wheelchairs, walkers, crutches). The evacuation procedure must be explained to students before any laboratory work begins (preferably the first day of school), and special evacuation arrangements for students with assistive devices must be outlined and submitted to the principal.
7. Teachers must ensure that students clean up their work area after completing laboratory activities. In addition, teachers must ensure that students wash their hands after laboratory work or any time they must leave the laboratory area as needed.
8. Teachers must never tolerate inappropriate behavior or unauthorized experiments in the laboratory. One person's misconduct poses a hazard to everybody else in the laboratory. Students, who engage in physical horseplay, sabotage of others' work, or unauthorized "experiments" must be removed from the laboratory immediately.
9. Teachers are required to advise students of their rights and responsibilities relating to laboratory safety. Laboratory safety training must precede all laboratory work and become an integral part of the science curriculum. The teacher will obtain and keep documentation that students and parents have been informed of safety expectations.
10. Teachers will introduce the safety program by providing students with a personal copy of the **Student Safety Contract** that includes a list of *core* precautions to be used with students in all courses. Additional precautions that are specific to a course or a laboratory experiment may be added as needed. All students, in instructional areas that use chemicals, shall be trained annually in the safe management of chemicals specific to that area.

(These items are mandatory for compliance to Title 14, Regulation 885)

All students shall sign a student safety contract at the conclusion of this training. The training shall include at least the following:

- An overview of the school safety program;
- The location of all Hazardous Chemical containers in the Instructional Area;
- An explanation of how to read labels on containers;
- The location, availability and content of Material Safety Data Sheets (MSDS) and an explanation of how they are used;
- An explanation of the nature of Health Hazards and Physical Hazards associated with the use of all Hazardous Chemicals (regardless of quantity) to which they may be exposed;
- An explanation of the proper handling, Storage and disposal methods for each of the Hazardous Chemicals present in the Instructional Area; and
- Measures taken by the instructional staff and school personnel to prevent or control Exposure such as engineering controls, personal protective equipment, and emergency procedures for spills or leaks.

11. Teachers shall only conduct laboratory activities that conform to district and/or state curriculum & instruction guidelines.

12. Careful planning is expected for all activities. The following questions can be used to guide planning for a particular unit or activity.

- What are the hazards?
- What are the "worst case" scenarios and how can I prepare for them?
- What practices, safety equipment, and protective facilities are prudent and appropriate?
- Have I performed a "dry run" of the activity to prepare for any potential problems?
- Is there adequate staff support to deal with unforeseen hazards?

13. Before any actual laboratory work begins, students shall be instructed in emergency procedures, including evacuations. The teacher shall review the particular safety rules and procedures most appropriate to the activity, and answer all student questions prior to beginning and monitor the students' activities closely.

14. Teachers shall not leave students engaged in laboratory work unsupervised at any time for any reason. If the classroom must be evacuated during laboratory work, the teacher must ensure that no hazardous conditions exist before leaving the room.

15. Teachers should only conduct laboratory experiments when a school nurse or medical staff member is present in the building. If teachers are conducting an experiment after the school day (in preparation for later instruction), they should ensure that another teacher is present that is familiar with the risks associated with the procedure.

16. Teachers shall be aware of any health concerns of students that laboratory work may affect. These might include allergies, disabilities, temporary or chronic illnesses, or pregnancy. Teachers shall work with the school administration, the school nurse, and the students' families to obtain current and accurate information.
17. Because of the increasing frequency and life threatening nature of latex allergies resulting from airborne latex particles, many schools have forbidden activities involving latex balloons or latex gloves. This restriction applies to both laboratory work and to teacher demonstrations. Teachers shall ensure that activities do not violate district/school guidelines regarding the use of latex materials.
18. Teachers shall report any injury that occurs during a laboratory exercise, however minor, to the school nurse and school administration immediately. Teachers shall never administer medication (including topical agents or cough drops) to any student. If the incident is serious enough that the student cannot be moved, the teacher shall summon the nurse and keep the area around the student clear. **As a general rule, teachers should not administer first aid to students unless the student's life is in danger. This typically also applies to administering adhesive bandages for cuts. All situations requiring first aid and medical treatment must be handled by the nurse.** (See local district and/or school policy regarding this topic).
19. Teachers shall ensure that appropriate laboratory apparel and etiquette are observed. In particular, certain lab activities may require the following:
- Safety goggles must be worn when certain labs with chemicals, glassware, or heat (hot plates or open flame) occur. Goggles that meet ANSI standard Z87.1 are appropriate for all of these situations, and are specifically required for certain chemistry labs. Contact lenses are not restricted.
 - Laboratory aprons should be worn during certain chemistry labs.
 - Protective gloves should be worn when students handle bacterial cultures or preserved specimens. Due to allergies, latex gloves should be avoided.
 - Laboratory workers (students) must never eat, drink, chew gum, or apply cosmetics when working with chemicals or biological materials.
 - Students with shoulder length hair must secure it behind their shoulders.
 - Students must secure loose fitting clothing and remove or secure dangling jewelry.
 - Teachers are responsible for modeling appropriate laboratory etiquette. Modeling is the most effective teaching method. Also, visitors to the class (including administration) are required to use any precautions or safety equipment (e.g. goggles) that are required of students.
20. The district's safety plan shall be reviewed and updated annually by staff members.

Good Samaritan Act

Any person, who in good faith gratuitously renders emergency care at the scene of an accident or emergency to a victim thereof, shall not be liable for any civil damages for any personal injury resulting from an act or omission by the person rendering the emergency care or as a result of any act or failure to act to provide or arrange for further medical treatment or care for the injured person, except acts or omissions amounting to gross negligence or willful or wanton misconduct. The exemptions from civil liability provided by this chapter shall not apply to the administering of such care where the same is rendered for remuneration or with the expectation of remuneration, or is rendered by any person or agent of a principal who was at the scene of the accident or emergency because he or his principal was soliciting business or performing or seeking to perform emergency care services for remuneration.

(Source: 16 Del. C. 1953, #6801; 58 Del. Laws, c. 105; 59 Del. Laws, c. 361, #1.)

C. Safety Responsibilities of the Chemical Safety Officer

1. Act as liaison among science teachers, building and district administration, and facilities staff regarding chemical safety issues.
2. Maintain the chemical inventory for the school(s). This inventory is updated annually and shared with the building principal(s) and other necessary persons.
3. Approve all chemical orders by the district or school.
4. Maintain a supply of Material Safety Data Sheets (MSDS) for all chemicals in the chemical inventory. Copies of these are shared with the building principal, the chief custodian, and the school nurse.
5. Assist teachers with maintenance requests related to safety equipment and issues.
6. Identify and coordinate disposal of surplus hazardous chemical wastes.

*(See also Title 14, Regulation 885, Section 5.0 *Inventory of Chemicals, Hazardous and Non-Hazardous* and Section 9.0 *Disposal of Surplus Chemicals*)*

D. Safety Responsibilities of the Administration

1. The school's administration shall cooperate fully with teachers and the Chemical Safety Officer to maintain a safe environment for laboratory investigation.
2. Principals shall ensure that the instructional facilities meet all state and national requirements for safety. Although laboratory investigation is a crucial part of effective instruction, a safe environment is an absolute prerequisite for laboratory investigation. This includes provision of fire extinguishers, fire blankets, and goggles with sanitizing goggle cabinets. Principals shall ensure that chemicals are stored in secure storage facilities with limited access.
3. The number of students in a classroom and the allotted space for laboratory work are crucial components of laboratory safety. As students are scheduled in classes, administrators shall work with teachers and guidance counselors to ensure that classes are small enough to allow adequate room for students to move easily and to allow teachers to supervise students safely.
4. Principals shall not schedule science classes to routinely meet in classrooms that are not dedicated to science instruction. If such scheduling is necessary, the affected classes shall have access to an appropriate laboratory on those days when students will conduct experiments and this situation should be for temporary and/or emergency situations only.
5. Principals shall not schedule teachers of subjects other than science to teach regular classes in science classrooms and/or laboratories. If a hazardous situation involving chemicals should occur, the teacher may not be equipped to intervene and compromises the entire school safety program.
6. Principals shall respond to maintenance requests that affect the safety level of the classroom promptly. If there is a delay in processing such requests, the principal must keep the teacher informed.
7. Administrators shall enforce appropriate disciplinary actions for safety infractions according to the severity of the infraction. If a student's behavior in the laboratory poses a consistent safety hazard to that student and/or the rest of the class or school community, that student should be removed from classes and appropriate interventions be pursued.
8. Principals shall ensure that an inventory of all chemicals is in the building and the MSDS for each chemical is maintained. Principals shall ensure that the school building is in compliance with Title 14, Regulation 885 – *Safe Management, Storage, and Disposal of Chemicals in the Delaware Public School System*.

E. Safety Responsibilities of the District Science Supervisor or Specialist

1. Hold periodic safety meetings to address issues relevant to laboratory safety at the classroom level, the school level, and the district level in conjunction with the Chemical Safety Officer.
2. Assist the Chemical Safety Officer in the preparation and revision of the Chemical Safety Plan.
3. Provide periodic safety training for teachers and keep records of training. Assist new teachers to understand the District Safety Plan and “best practices” in laboratory safety.
4. In conjunction with the Chemical Safety Officer, maintain records of each school’s chemical inventory, and provide schools with any necessary MSDS sheets. These inventories will be used to assist teachers with maintaining fresh chemicals and safely disposing of surplus chemicals.
5. Attend state level safety meetings and disseminate information from these meetings to district personnel as needed.
6. Assist teachers, the Chemical Safety Officer, and administrators in meeting safety requirements as required by law. This may include recommendations for space usage, finding safety resources for teachers, and arranging for disposal of hazardous surplus chemicals.



IV. IMPORTANT DEFINITIONS IN UNDERSTANDING LABORATORY SAFETY

IV. IMPORTANT DEFINITIONS IN UNDERSTANDING LABORATORY SAFETY

For classroom teachers to work successfully in the safety arena, they must understand how definitions apply to the laboratory and/or any other instructional area. OSHA definitions are commonly used as legal definitions and help to foster understanding of standard operating procedures. This in turn helps teachers plan better and work toward securing and maintaining a safe work environment in the laboratory for all occupants.

Working definitions include the following:

Carcinogen means any chemical that can cause cancer. Included are known or suspected carcinogens such as formaldehyde, benzene, carbon tetrachloride, nickel salts, sodium dichromate and sodium chromate.

Chemical means any element, compound, or mixture of elements and/or compounds.

Chemical Name means the scientific designation of a chemical in accordance with the nomenclature system developed by the International Union of Pure and Applied Chemistry (IUPAC) or the Chemical Abstracts Service (CAS) rules of nomenclature, or a name which will clearly identify the chemical for the purpose of conducting a hazard evaluation.

Chemical Safety Officer means an employee who the school district or charter school designates, and who is qualified by training or experience, to provide technical guidance in the development and implementation of the provisions of the chemical safety plan.

Chemical Safety Plan means a written program developed and implemented by the school district or charter school that sets forth specific procedures, personal protective equipment and work practices that are capable of protecting students and school employees from the health hazards presented by hazardous chemicals.

Combustible liquid means any liquid having a flashpoint at or above 100 degrees Fahrenheit (37.8 degrees Celsius), but below 200 degrees Fahrenheit (93.3 degrees Celsius), except any mixture having components with flashpoints of 200 degrees Fahrenheit (93.3 degrees Celsius), or higher, the total volume of which make up 99 percent or more of the total volume of the mixture.

Common Name means any designation or identification such as a code name, code number, trade name, brand name, or generic name used to identify a chemical other than its chemical name.

Compressed gas means:

- A. a gas or mixture of gases having, in a container, an absolute pressure exceeding 40 psi (2.8 kg/cc) at 70 degrees Fahrenheit (21.1 degrees Celsius); or
- B. a gas or mixture of gases having, in a container, an absolute pressure exceeding 104 psi (7.3 kg/cc) at 130 degrees Fahrenheit (54.4 degrees Celsius) regardless of the pressure at 70 degrees Fahrenheit (21.1 degrees Celsius); or
- C. a liquid having a vapor pressure exceeding 40 psi (2.8 kg/cc) at 100 degrees Fahrenheit (37.8 degrees Celsius) as determined by ASTM D-323-72.

Corrosive means a chemical that causes visible destruction of or irreversible alterations in, living tissue by chemical action at the site of contact.

Emergency means any occurrence such as, but not limited to, equipment failure, rupture of containers or failure of control equipment that results in an uncontrolled release of a hazardous chemical into the workplace.

Employee means an individual employed in a laboratory workplace that may be exposed to hazardous chemicals in the course of his or her assignments.

Explosive means a chemical that causes a sudden, almost instantaneous release of pressure, gas and heat when subjected to sudden shock, pressure or high temperature.

Expose or Exposure means an instance where an individual is subjected to a hazardous chemical through any route of entry (inhalation, ingestion, skin contact or absorption, etc.) and includes potential (e.g., accidental or possible) exposure.

Flammable means a chemical that falls into one of the following categories:

- A. **Aerosol, flammable** means an aerosol that, when tested by the method described in 16 CFR 1500.45, yields a flame protection exceeding 18 inches (45.7 cm) at full valve opening, or a flashback (a flame extending back to the valve) at any degree of valve opening.
- B. **Gas, flammable** means:
 1. a gas that, at ambient temperature and pressure, forms a flammable mixture with air at a concentration of 13 percent by volume or less; or
 2. a gas that, at ambient temperature and pressure, forms a range of flammable mixtures with air wider than 12 percent by volume, regardless of the lower limit.
- C. **Liquid, flammable** means any liquid having a flashpoint below 100 degrees Fahrenheit (37.8 degrees Celsius), except any mixture having components with flashpoints of 100 Fahrenheit (37.8 degrees Celsius) or higher, the total of which make up 99 percent or more of the total volume of the mixture.

- D. **Solid, flammable** means a solid, other than a blasting agent or explosive as defined in §1910.109(a), that is liable to cause fire through friction, absorption of moisture, spontaneous chemical change, or retained heat from manufacturing or processing, or that can be ignited readily and when ignited burns so vigorously and persistently as to create a serious hazard. A chemical shall be considered to be a flammable solid if, when tested by the method described in 16 CFR 1500.44, it ignites and burns with a self-sustained flame at a rate greater than one-tenth of an inch per second along its major axis.

Flashpoint means the minimum temperature at which a liquid gives off a vapor in sufficient concentration to ignite.

Hazardous Chemical means any chemical that presents a physical hazard or health hazard

Health Hazard means a chemical for which there is statistically significant evidence based on at least one study conducted in accordance with established scientific principles that acute or chronic health effects may occur in exposed employees. The term “health hazard” includes chemicals that are carcinogens, toxic or highly toxic agents, reproductive toxins, irritants, corrosives, sensitizers, hepatotoxins, nephrotoxins, neurotoxins, agents that act on the hematopoietic systems, and agents that damage the lungs, skin, eyes or mucous membranes. The material safety data sheet (MSDS) will provide information to determine whether or not the chemical is a physical hazard.

Instructional Area means a room or defined space used for an educational activity. An instructional area may be a classroom, a laboratory, a field, a special building such as a greenhouse, or any other space where educational activities may take place.

Laboratory means an instructional area where the “laboratory use of hazardous chemicals” occurs in an educational environment. It is a workplace where relatively small quantities of hazardous chemicals are used on a nonproduction basis for educational purposes.

Laboratory scale means work with substances in which the containers used for reactions, transfers, and other handling of substances are designed to be easily and safely manipulated by one person. “Laboratory scale” excludes those workplaces whose function is to produce commercial quantities of materials.

Laboratory-type hood means a device located in a laboratory, typically with an enclosure on five sides with a movable sash or fixed partial enclosed on the remaining side; constructed and maintained to draw air from the laboratory and to prevent or minimize the escape of air contaminants into the laboratory; and allows chemical manipulations to be conducted in the enclosure without insertion of any portion of the employee’s body other than hands and arms. (See also **Fume Hood** in Section VI – *General Laboratory Safety Specifications*, #2 & #3)

Laboratory use of hazardous chemicals means handling or use of such chemicals in which all the following conditions are met:

- A. Chemical manipulations are carried out on a “laboratory scale.”
- B. Multiple chemical procedures or chemicals are used.
- C. The procedures involved are not part of a production process, nor in any way simulate a production process.
- D. “Protective laboratory practices and equipment” are available and in common use to minimize the potential for individual exposure to hazardous chemicals.

Long-Term Storage means the storage of any chemical for a time period past the end of the school day.

Material Safety Data Sheet (MSDS) means a document that contains information on the potential health effects of exposure to chemicals, or other potentially dangerous substances, and on safe working procedures when handling chemical products. It is an essential starting point for the development of a complete health and safety program. It contains hazard evaluations on the use, storage, handling and emergency procedures related to that material. The MSDS contains much more information about the material than the label and it is prepared by the supplier. It is intended to tell what the hazards of the product are, how to use the product safely, what to expect if the recommendations are not followed, what to do if accidents occur, how to recognize symptoms of overexposure, and what to do if such incidents occur.

Medical consultation means a consultation that takes place between a person and a licensed physician for the purpose of determining what medical examinations or procedures, if any, are appropriate in cases where a significant exposure to a hazardous chemical may have taken place.

Non-hazardous Chemical means any element, compound or mixture of elements and/or compounds which do not present a physical hazard or health hazard.

Occupational Safety and Health Administration (OSHA) means the government agency in the Department of Labor that develops guidelines to maintain a healthy and safe working environment.

Organic peroxide means an organic compound that contains the bivalent -O-O- structure and that may be considered to be a structural derivative of hydrogen peroxide where one or both of the hydrogen atoms has been replaced by an organic radical.

Oxidizer means a chemical other than a blasting agent or explosive as defined in § 1910.109(a), that initiates or promotes combustion in other materials, thereby causing fire either of itself or through the release of oxygen or other gases.

Physical hazard means a chemical for which there is scientifically valid evidence that it is a combustible liquid, a compressed gas, explosive, flammable, an organic peroxide, an oxidizer pyrophoric, unstable (reactive) or water-reactive. The material safety data sheet (MSDS) will provide information to determine whether or not the chemical is a physical hazard.

Protective laboratory practices and equipment means those laboratory procedures, practices and equipment accepted by laboratory health and safety experts as effective, or that the employer can show to be effective, in minimizing the potential for individual exposure to hazardous chemicals.

Reproductive toxins mean chemicals that affect the reproductive capabilities including chromosomal damage (mutations) and effects on fetuses (teratogenesis).

Short-Term Storage means the storage of any chemical for a time period before the end of the school day.

Storage means a space for the containment of chemicals or other materials.

Surplus Chemical means any chemical that is no longer useable or needed.

Unstable (reactive) means a chemical that is the pure state, or as produced or transported, will vigorously polymerize, decompose, condense, or will become self-reactive under conditions of shocks, pressure or temperature.

Useable means that the chemical or other material has not surpassed its expiration date.

Water-reactive means a chemical that reacts with water to release a gas that is either flammable or presents a health hazard.



V. BASIC PRINCIPLES OF LABORATORY SAFETY

V. BASIC PRINCIPLES OF LABORATORY SAFETY

To control a person's exposure to chemical and other hazards in the laboratory, three general principles for laboratory safety are typically put into place.

These include:

- A. Engineering controls
- B. Administrative controls (work practices)
- C. Personal protective equipment

By designing laboratory work using one of these basics or a combination of them, employees can keep their exposure levels well below the permissible exposure limit (PEL).

To protect students and teachers from exposure to hazardous chemicals there is a hierarchy of defense. The hierarchy is as follows in implementation:

First line of defense — engineering controls (environmental settings/considerations).

Second line of defense — administrative controls (work practice).

Third line of defense — personal protective equipment.

A. Engineering Controls (Environmental Settings/Considerations)

Engineering controls are the primary method in dealing with laboratory hazards. These controls remove or reduce exposure to a chemical or physical hazard by using or substituting engineered machinery or equipment. Examples include the following:

- Selection of a less toxic chemical.
- Alternate process to minimize interaction with hazardous chemicals such as using a computer simulation or probeware.
- Self-capping syringe needles.
- Use of wet methods to reduce generation of dusts or other particulates.
- Sound dampening materials for reduction of noise levels.
- General laboratory ventilation.
- Isolated exhaust such as a fume hood.
- Radiation shielding.

B. Administrative Controls (Work Practices)

Administrative controls or work practice controls involve changes in work procedures to better protect the employee and student. This is achieved through written safety protocols/ policies/ procedures, supervisory activities, and training/resources.

Examples include:

- Housekeeping — keeping the laboratory work area clear of clutter will reduce the possibility of an accident.
- Prohibiting access to laboratories where hazards such as chemical and lasers or ionizing radiation are being used.

C. Personal Protective Equipment (PPE)

In cases where engineering controls are not sufficient to provide exposure protection for employees, personal protective equipment must be used. Personal protective equipment includes clothing or devices worn to help protect an employee from direct exposure to a safety hazard or situation. Examples of personal protective equipment include protective clothing (aprons), hand protection (gloves), eye protection (chemical splash goggles and safety glasses) and respiratory protection (particulate respirator). Material Safety Data Sheets are a good resource for recommended personal protective equipment when working with hazardous chemicals.



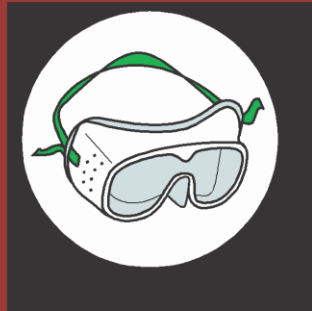

VI. GENERAL LABORATORY SAFETY SPECIFICATIONS

VI. GENERAL LABORATORY SAFETY SPECIFICATIONS

General science or interdisciplinary science broadly focuses on scientific research, knowledge and inquiry. It is the holistic approach to basic science literacy. In Delaware schools, curriculum and assessment work toward achieving this goal by exposing students to a myriad of experiences and study. Hands-on, process and inquiry techniques are encouraged through laboratory and field work. To provide exciting and safe experiences for students, the following safety specifications and prudent practices are highly recommended and in most cases required by regulatory agencies (DDOE, OSHA, NFPA, ICC, etc.).

A. Environmental Settings and Considerations

1. Laboratory Footprint

(These items are mandatory for compliance to Title 14, Regulation 885)

The work area is the first line of defense for safety by design. This includes the instructional area (experimental area), the preparation room, and the chemical storage room.

Footprint safety requirements:

- a) There must be separate rooms for laboratory activities and the storage/preparation of chemicals.
- b) Furniture placement in laboratories must be designed in such a way as to facilitate easy movement, fast egress, direct observation/supervision and no trip/fall hazards.
- c) Rooms, laboratories, and other instructional areas that use hazardous chemicals must have two exits. The second exit, for emergency purposes only, can pass through a non-chemical storage room. [adapted from NFPA 101 Life Safety Code, 15.2.5.4]
- d) Rooms, laboratories, and other instructional areas that use hazardous chemicals must provide adequate space for student work at a minimum of 50 square feet per student. National sources suggest that student loads not exceed a maximum of 24 students per laboratory. [adapted from NFPA 101 Life Safety Code and NSTA recommendations]
- e) The laboratory shall be handicap accessible, meeting ADA requirements, relative to furniture, fixtures, etc.
- f) All laboratories and/or other instructional areas that use hazardous chemicals must have basic safety equipment that includes the following:
 - Eyewash (running water, continuous flow style)
 - Acid/Chemical shower (continuous flow style)
 - Eye protection (wrap-around, splash-shield style goggles)
 - Fire extinguisher
 - Fire blanket
 - Chemical spill equipment

If the instructional area is outside of the physical school building (i.e. a field or outdoor classroom), students must have access to safety equipment in the main building.

SAMPLE SCIENCE LABORATORY LAYOUTS:

**Combination Classroom/Laboratory
Room Size is 30' x 40' —1,200 sq. ft.**

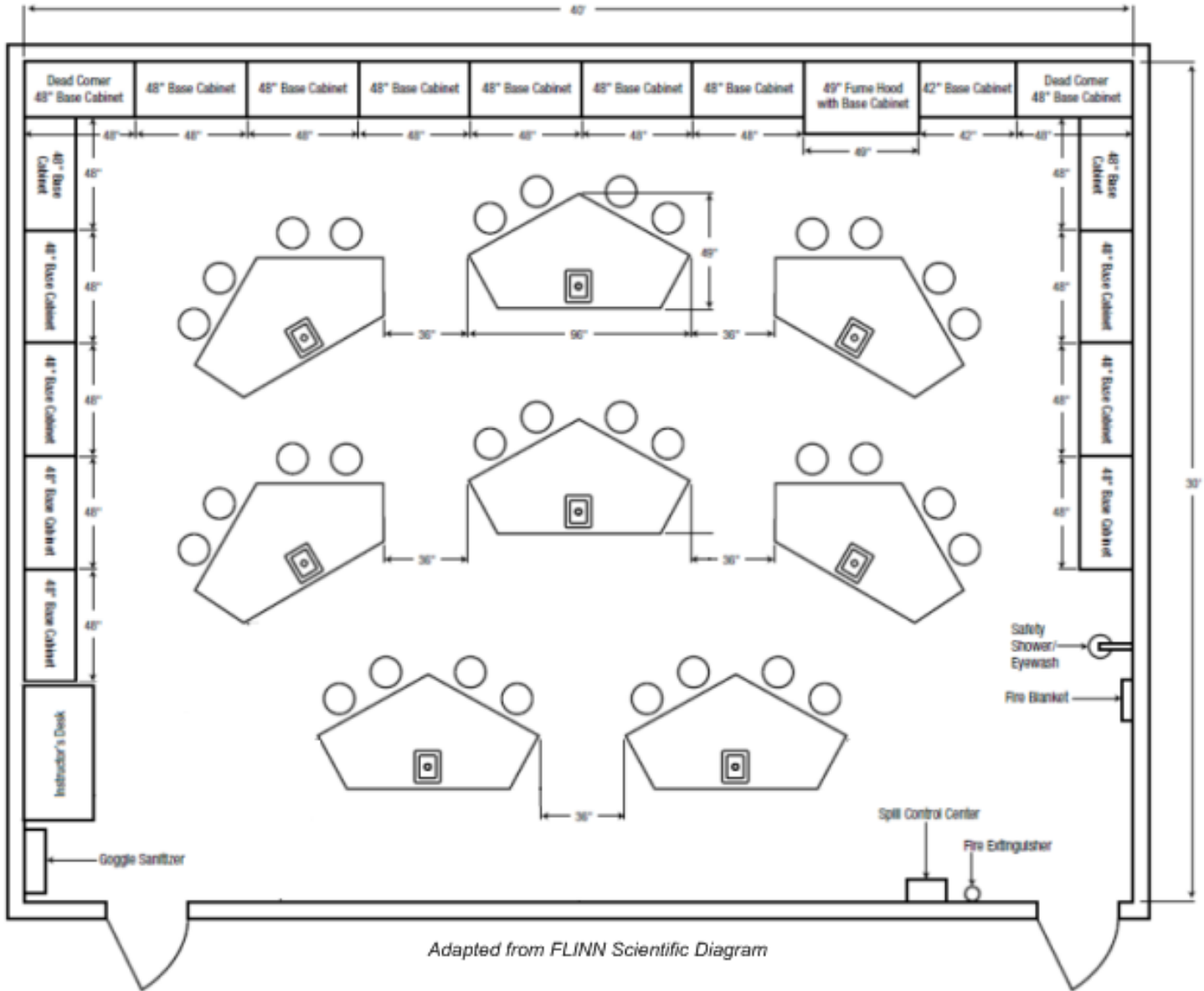

SAFETY FIRST: Safe Instructional Practices in the Classroom & Laboratory

Combination Classroom/Laboratory—Flexible
38' × 30' — 1,140 sq. ft.

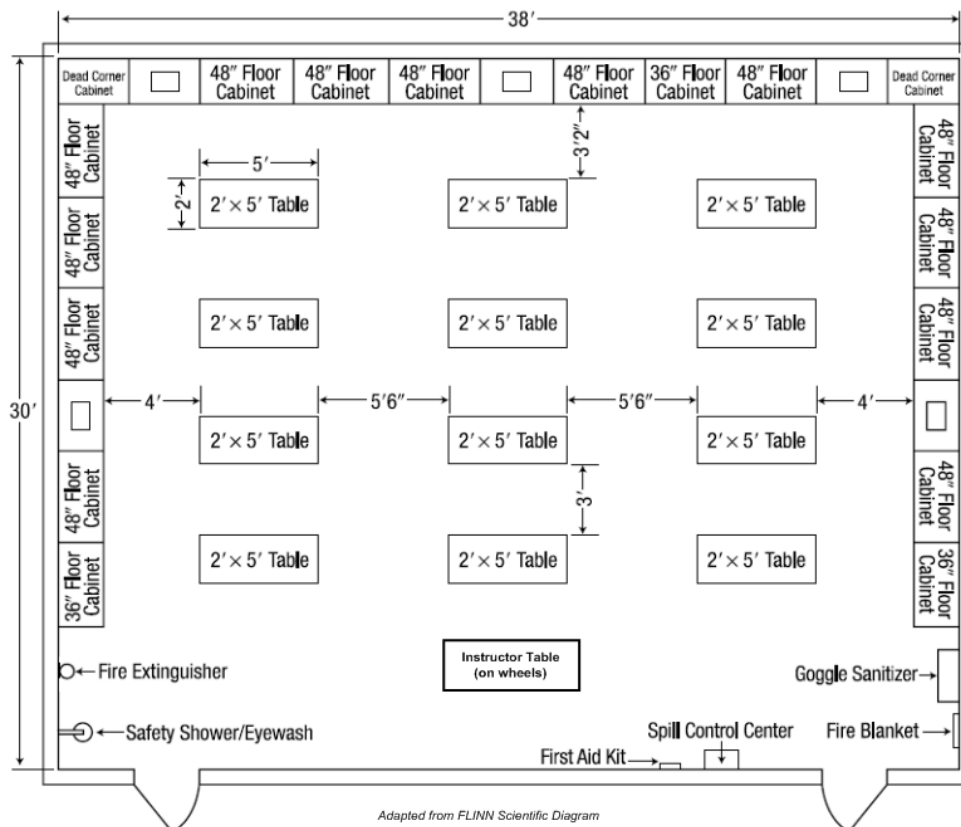
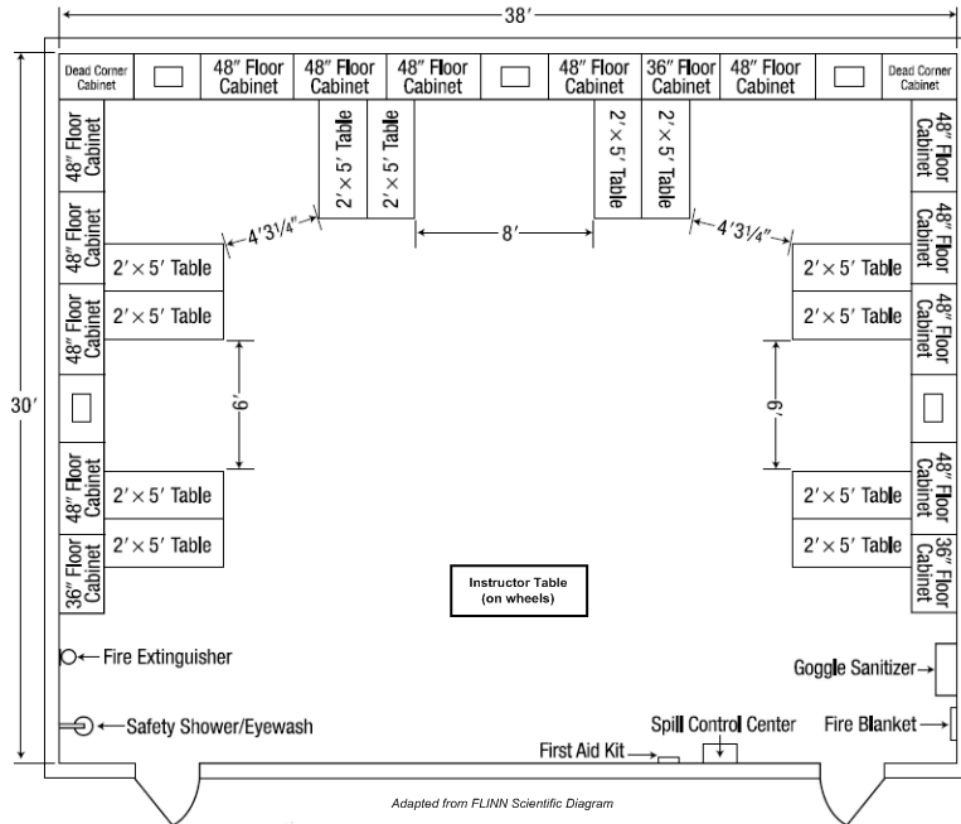

Combination Classroom/Laboratory—Divided
30' x 40' — 1,200 sq. ft.

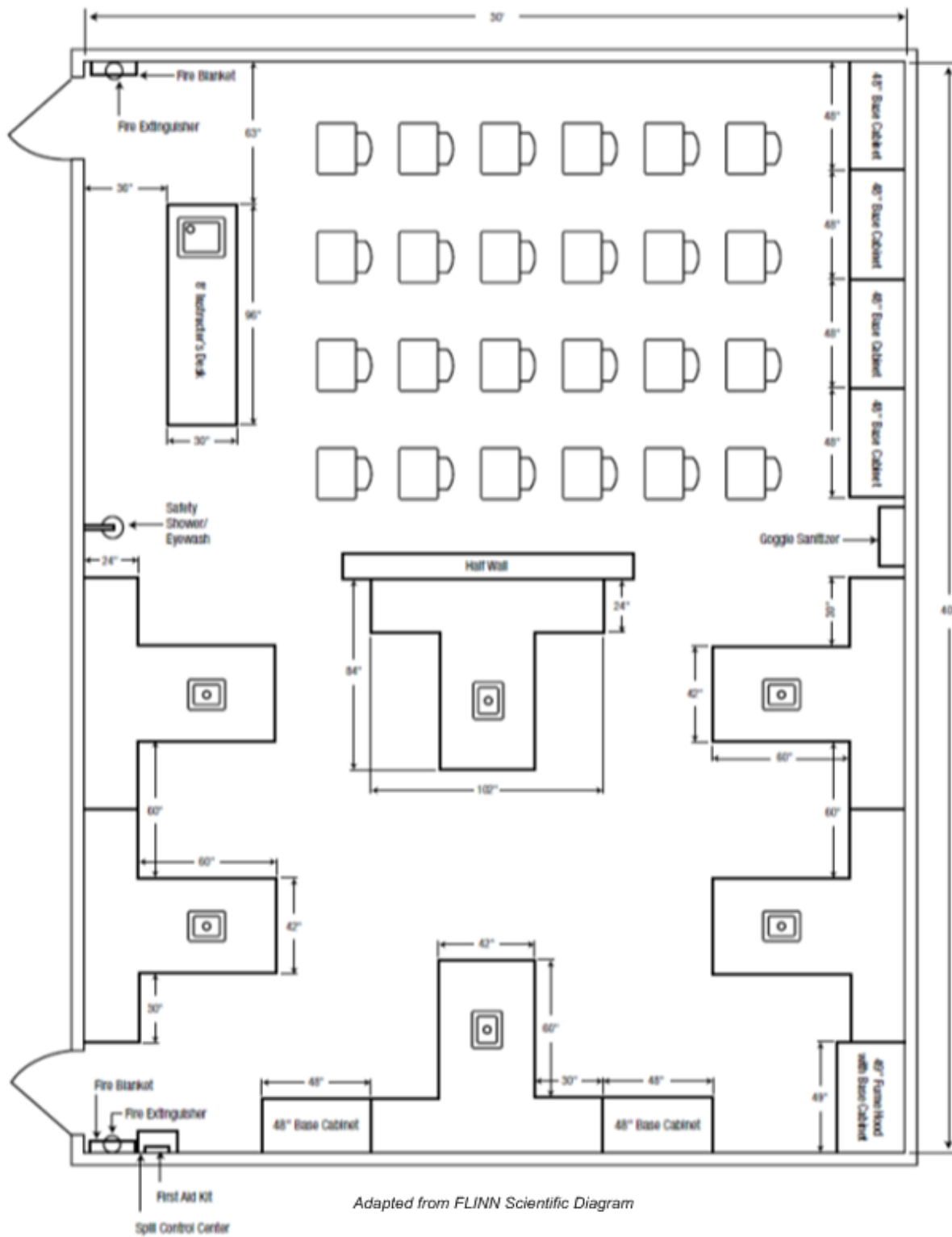

2. Fume Hood

(These items are mandatory for compliance to Title 14, Regulation 885)

Definition – A fume hood is an engineering control that provides local exhaust ventilation. It usually has a moveable front sash or window with safety glass. The hood is essential in exhausting hazardous gases, particulates, vapors, etc. It protects both students and teachers from inhalation exposure.

A properly functioning fume hood and/or other industry-standard ventilation system shall be used when mixing chemicals, using chemicals, and/or for short-term storage of chemicals that release hazardous fumes. The determination that a fume hood or other ventilation system is necessary shall be based on a hazard analysis and a review of the MSDS document(s).

Fume hood safety requirements:

- a) Use the hood to remove airborne chemicals, such as aerosols, dust, fumes and vapors.
- b) Hoods are not for storage. Keep them clean of chemicals and glassware.
- c) Place apparatus as far back to the rear of the hood for efficient air flow.
- d) Make sure only necessary materials are under the hood during an operation.
- e) Avoid having students work opposite a fume hood.
- f) Always keep the sash between the face and experiment with the sash lowered.
- g) Check the air flow before and during the operation [Face velocity of 80-120 feet per minute (24.4-36.6 meters per minute)].
- h) Hoods should be checked regularly and certified operational one to four times a year, depending on frequency of use.
- i) Never block the air flow into or inside the hood.
- j) Do not use the hood as a waste disposal device for organic chemicals.
- k) Do not use the hood for explosives, perchloric acid or radioisotopes.

3. Laboratory Ventilation

(These items are mandatory for compliance to Title 14, Regulation 885)

Ventilation in a laboratory is critical for a safe and healthy operation. Little or no ventilation can allow the buildup of explosive or flammable vapors, respiratory symptoms and more.

Ventilation safety includes the following:

- a) Occupied Lab air exchange rates should be six to 10 times an hour based on American Society of Heating, Refrigerating and Air Conditioning Engineers (ASHRAE) handbook or greater than eight air exchanges per NFPA 45. *Contact the director of your school facilities to have the air exchange rate accessed.*
- b) Unoccupied lab air exchange rates, including chemical storerooms, should be four times an hour per NFPA 45.
- c) Air supplies to labs, storerooms, preparation rooms should never be recycled to any other part of the building, other labs, classrooms and offices.
- d) Only conduct experiments that the ventilation system can handle. Otherwise, use a fume hood or select an alternate experiment. Limit occupant exposure.
- e) Preventative maintenance programs should be in place to change ventilation filters about four times a year. Filters typically need to be changed on a quarterly basis.

A good resource for laboratory ventilation is NFPA 45. It addresses required forced air ventilation in science laboratories, including academic labs, and other instructional areas.

4. Utility Controls

Laboratory facilities must have master shut-off devices for utilities such as electricity and gas. Water shut-off devices can be located outside of the laboratory in a corridor.

5. Alarm Sensors

Heat sensors or smoke detectors and fire suppression system sensors are necessary for a safe laboratory, especially during unoccupied times.

7. Eyewash and Acid/Chemical Shower

(These items are mandatory for compliance to Title 14, Regulation 885)

An eyewash and acid shower are necessary in case of a chemical exposure incident. These devices must be in locations where occupants are provided direct access. (OSHA and the American National Standards Institute or ANSI (Z358.1-1998) standard require 10 second access to any eyewash/acid shower in the laboratory). Additional eyewash stations are needed if the 10-second access is not possible with one station in the laboratory. Eyewashes require exposure to tepid water [60–100 degrees Fahrenheit (15.6–37.8 degrees Celsius)] for 15 minutes minimum at a prescribed flow rate of 0.40 gallon (1.5 liters) per minute minimum. Portable eyewash squeeze bottles cannot be used as the primary eyewash. They provide an inadequate water supply and foster the growth of microorganisms.

All rooms using hazardous chemicals must have an eyewash and acid/chemical shower installed in the room. Acid or safety showers must provide a minimum flow of 30 gallons (113.6 liters) per minute with uninterrupted flow of tepid water.

Eyewashes and showers may have a drain, but are not required by code to have floor drains.

Eyewashes are to be inspected (flushed for about three minutes) once a week per the manufacturer's expectations to clear out sediments, biological contaminants, etc. Safety showers are to be inspected (flushed for several minutes) once per month.



7. Safety Shields

In some instances such as demonstrations, safety shields may also be used, in addition to chemical splash goggles.

8. Fire suppression

(These items are mandatory for compliance to Title 14, Regulation 885)

Given the dangers of hazardous chemicals and chances for fire and explosion, fire suppression equipment is an NFPA requirement. Fire extinguishers should be of the A-B-C type (A – combustibles like wood, paper, B – flammables like alcohol, C – electrical) (also type D for metals such as magnesium, potassium, sodium, etc.). Teachers should be trained annually for proper use of extinguishers. Check with your district and/or school policy on employee use for fire extinguishers.

Use the following NFPA “PASS” approach when working with a first extinguisher:

P – Pull the pin

Most extinguishers use locking pin to prevent inadvertent operation. Pulling the pin unlocks the operating level to allow discharge operation.

A - Aim low

Point the extinguisher nozzle at the base of the fire.

S - Squeeze the lever

A lever below the handle or some other type of triggering device must be engaged to release the extinguishing agent.

S - Sweep from side to side

Using a sweeping motion across the base of the fire and continue discharging the extinguishing agent until the fire appears to be out. Be certain to watch the fire area; if the fire reignites, repeat the process.

Signs are to be posted to show the locations of fire extinguishers, particularly in instructional areas where they could be easily blocked from view. The signs should be large enough to be seen clearly from a distance.



Portable extinguishers weighing more than 39.7 pounds (18 kilograms) are to be installed so that the top is not more than 3.6 feet (1.1 meters) or above the floor. Those weighing 39.7 pounds or less (18 kilograms or less) must not be more than 5 feet (1.5 meters) above the floor.

Travel distance for Class D portable fire extinguishers is not to be more than 75 feet (22.9 meters) from the hazard [29 CFR 1910.157(d)(6)]. Travel distance for Class ABC portable fire extinguishers is not to be more than 50 feet (15.2 meters) or less from the hazard [29 CFR 1910.157(d)(4)].

9. Fire Blanket

(These items are mandatory for compliance to Title 14, Regulation 885)

Flame-retardant wool or other types of materials can be helpful in smothering small fires. Never wrap a standing person on fire in a fire blanket. This can create a “chimney effect.” Wall-mounted canisters or boxes with appropriate signage must be used.

10. Goggle Sanitizer

Ultraviolet (UV) goggle sanitizer cabinets are available and take about 15 minutes to sanitize goggles. Goggles must be sanitized if used by more than one student. Alternatives to sanitizers include disinfectants, alcohol or dish detergent.

11. Electrical Safety Controls

All laboratories, storerooms and preparation rooms must have ground fault circuit interrupters (GFCI) electrical receptacles to protect occupants from electrical shock. This is supported by OSHA relative to the 6-foot (1.8 meters) water source application. However, given that water use can be anywhere in the laboratory (e.g. aquarium, ripple tanks, wave tanks and more), it is prudent to have the total laboratory with GFCI receptacles. One note – touching both metal prongs while plugging into wall receptacle will not protect the user.

B. Prudent Work Practices

12. Acids

Acids are very dangerous and must be handled with extreme care. When diluting acid with water, think “AAA” — ALWAYS ADD ACID TO WATER! Slowly stir and swirl the contents, being watchful of the heat produced, particularly with sulfuric acid.

13. Animal Care

Foster proper handling, humane care and treatment of animals in the classroom, laboratory, barn, or other instructional area. Check your local district/charter school policies on animal care and use in instruction for the classroom. (See also *Section IX, Biology Laboratory Safety Specifications*).

14. Authorized Access

(These items are mandatory for compliance to Title 14, Regulation 885)

Authorized teachers, school/district Chemical Safety Officer, department heads, principals and trained custodians are the only employees who should have key access to laboratories, preparation rooms and chemical storerooms. Do not permit unauthorized persons in any laboratory, preparation room or storeroom where hazards exist, e.g., hazardous chemicals and sophisticated equipment. OSHA considers laboratories, preparation rooms and storerooms as secured areas.



15. Student Behavior

- a) All students must sign a student safety contract that outlines the proper safety procedures specific to the class.
- b) Horseplay or other inappropriate behavior in the laboratory is forbidden.
- c) Instruct students to never taste chemicals or other laboratory materials.
- d) Instruct students to perform only experiments authorized by the teacher.
- e) Remind students never to do anything in the laboratory that is not called for in the laboratory procedures.
- f) Have students follow all instructions, both written and oral.
- g) Remind students that unauthorized experiments are prohibited.
- h) Have students report any accident or injury to the teacher immediately, no matter how simple it may appear.
- i) Instruct students to never return unused chemicals to their original containers.

16. Chemical Spill Control

(These items are mandatory for compliance to Title 14, Regulation 885)

A chemical spill center must be available in the chemical storage room, or in close proximity to it, and should be available to handle small spills in the laboratory. Large spills and leaks require evacuation and the immediate contact of the local fire department's hazmat team. A direct means of communications with the front office by phone or intercom must be available.

Spill kits must include:

- a) Neutralizing agents for acid spills (sodium hydrogen carbonate).
- b) Neutralizing agents for alkali spills (sodium hydrogen sulfate).
- c) Pick up equipment such as brush, broom, pail, dust pan.
- d) Personal protective equipment such as gloves and goggles.
- e) Inert absorbents such as sand and kitty litter.



17. Chemical Storage

(These items are mandatory for compliance to Title 14, Regulation 885)

- a) Chemical storerooms must be kept under lock and key with limited access to appropriate staff only. No students are to have unsupervised access to the chemical storage room at any time.
- b) Chemicals shall not be stored in the classroom for a time period extending beyond the end of the school day. At the end of the day, chemicals are to be secured temporarily in locked storage areas or in the chemical storeroom. All long-term chemical storage must be in a properly equipped chemical storage room.
- c) Chemical storerooms must be properly maintained and kept dry. Roof leaks, should they occur, must be addressed immediately.
- d) Chemical storerooms are to have appropriate ventilation (non-re-circulating). It is suggested that the room have a minimum of four room exchanges per hour.
- e) Chemical storage rooms must be in a temperature range of 50-80 degrees Fahrenheit. Chemicals must not be exposed to direct heat sources, sunlight, or highly variable temperatures.
- f) Chemical storerooms must have a chemical spill center in the room or in close proximity to the room.

g) Shelving must be made of finished wood or other chemical resistant material with a front lip approximately 0.75 inch (1.9 cm) to 1 inch (2.54 cm) high. All chemical storage shelving and cabinets are to be securely fastened to the wall or floor to prevent tipping over.

h) Chemicals must be stored using a system that segregates chemicals by hazard levels and/or class (flammable compressed gases, non-flammable compressed gases, flammable liquids, combustible liquids, flammable solids, corrosive acids, corrosive bases, oxidizers, organic peroxides, spontaneously combustible reactives, water reactives, explosives and radioactives).



i) Chemicals are to be organized by compatibility, not alphabetically. Incompatible chemicals are to be stored separately. For example, acetic acid and acetlehyde (acetaldehyde) could be adjacent neighbors on a shelf and are an incompatible pair. Chemicals should only be stored alphabetically within compatible groups.

j) All chemicals must have a date of purchase on the container. Older chemicals should be used first and degradation of older chemicals should be monitored.

k) Flammable liquids must be stored in National Fire Protection Association (NFPA) approved flammable storage containers and cabinets.

l) Flammable and combustible cabinets should not be directly vented. Venting of these cabinets is not recommended or required except for odor control of malodorous materials. The openings on the bottom and top of the cabinets should be sealed with bungs supplied with the cabinet. If the cabinets are to be vented, vent from the bottom openings and makeup air from the top openings [NFPA 30, 4-3.2].



Source: SciMatCo, A Division of Flinn Scientific

- m) Chemicals must be separated into organic and inorganic families, and then into compatible and related groups. Compatible groups can be separated by use of different shelves.
- n) Corrosive chemicals such as acids and bases must be stored in separate appropriate chemical storage cabinets.
- o) Nitric acid must be stored in a separate cabinet.
- p) Lithium, potassium and sodium metals are highly discouraged for use in the high school setting and must be stored under dry mineral oil.
- q) All peroxide-forming chemicals (e.g. ethyl ether) must be monitored for age and removed after recommended shelf life.
- r) Hazardous liquids must be stored within a secondary containment.
- s) No chemicals can be stored above eye level or on the floor. Heavy items must be stored on lower shelves only.
- t) Pressurized liquids and gasses must be stored and handled according to current OSHA regulations. Storage bottles must be kept to a small “lecture size” container unless the equipment demands a large tank size (gas chromatograph, MIG welder, etc.).



NITRIC ACID

Consumer Products / Office & School Supplies

Consumer products and Office/School supply products are exempt from hazardous chemical regulations when they are used as intended by the manufacturer only. Products such as hand sanitizer, marker board cleaner, and glass cleaner are therefore exempt, yet care should be taken in the storage of these products. Some consumer products, such as bleach and drain cleaner, may be determined non-exempt as a consumer product if the quantities are large and safe storage of the materials is not available. If the product is shipped with an MSDS, it must then be treated as a hazardous chemical. Consumer products and office supplies are governed by the *Consumer Product Safety Act*.

Family & Consumer Sciences

Materials used in the Family & Consumer Sciences must adhere to Department of Public Health Food Code and the ServSafe guidelines in regards to chemical storage.

Biology & Preserved Specimens

Preserved specimens, even though they contain a minimum amount of hazardous chemicals in the container, may be stored in a locked biology storage room or in a locked display cabinet in the classroom so long as adequate safety measures are taken to reduce and/or prevent exposure to hazardous chemicals.

Examples of storage groups that are related and compatible:**Inorganic Family**

- a) Metals, hydrides
- b) Halides, sulfates, sulfites, thiosulfates, phosphates, halogens
- c) Amides, nitrates (except ammonium nitrate), nitrites, azides
- d) Hydroxides, oxides, silicates, carbonates, carbon
- e) Sulfides, selenides, phosphides, carbides, nitrides
- f) Chlorates, perchlorates, perchloric acid, chlorites, hypochlorites, peroxides, hydrogen peroxide
- g) Arsenates, cyanides, cyanates
- h) Borates, chromates, manganates, permanganates
- i) Other inorganic acids (except nitric acid)
- j) Sulfur, phosphate, arsenic, phosphorus pentoxide

Organic Family

- a) Acids, anhydrides, peracids
- b) Alcohols, glycols, amines, amides, imines, imides
- c) Hydrocarbons, esters, aldehydes
- d) Ethers, ketones, ketenes, halogenated hydrocarbon, ethylene oxide
- e) Epoxy compounds, isocyanates
- f) Peroxides, hydroperoxides, azides
- g) Sulfides, polysulfides, sulfoxides, nitrites
- h) Phenols, cresols

Note: Suggested storage groups are listed as a model only. Usage of certain hazardous chemicals at the high school level is not encouraged, e.g., isocyanates, arsenates, cyanides, cyanates and others.

18. Clothing/Hair

Do not wear loose/baggy clothing or dangling jewelry. They are a safety hazard in the laboratory. Make sure long hair is tied back behind the ears.

19. Cold/Heat Protection

When dealing with cryogenic or very hot materials, use heat-safety items such as safety tongs, mittens, aprons and rubber gloves.

20. De-energizing Equipment

De-energize all equipment when leaving the laboratory and/or instructional area. Examples include unplugging equipment (like microscopes), shutting off gas valves (use the master gas shutoff), and shutting off all water faucets.

21. Evacuation Drills

Establish, provide signage, and practice laboratory evacuation drills. Gas and electricity should be shut off during evacuations.

Keep all exits and safety equipment free from obstructions in any way. No materials can be stored in the corridors or walkways.

22. First Aid

First aid kits should be available in each laboratory along with a written phone number for the school nurse's office for medical support in case of an incident. Check with the board of education's policy on employees administering first aid.

23. Food, Drink and Cosmetics

Eating, drinking and the use of cosmetics are prohibited in instructional areas where hazardous chemicals and/or biohazards are stored or are in use.

24. Glassware

Use caution when inserting and removing glass tubing from rubber stoppers. Lubricate glassware (tubing, thermometers, etc.) before attempting to insert it in a stopper. Protect your hands with towels or gloves when inserting glass tubing into, or removing it from, a rubber stopper.

Chipped, cracked or scratched glassware should never be used in the lab. Broken glassware must be placed in a box or hard plastic container with a plastic liner. Include appropriate signage. Always use glass drying racks to support glassware when drying.

25. Heating

Never leave an active burner unattended. Never leave anything that is being heated or reacting unattended. Turn off the burner or hot plate when not in use. Give hot items time to cool down before handling. Otherwise, use protective gloves and equipment (tongs, etc.).

26. Housekeeping & Hygiene

Instructional areas must be kept clean at all times. Students should only use laboratory instructions, worksheets and necessary equipment in the work area. Other materials such as backpacks, books, purses and jackets should be stored away from the laboratory work area. Personal hygiene is required before and after laboratory work by washing hands with soap and water.

27. Hazard Rating System

(These items are mandatory for compliance to Title 14, Regulation 885)

All chemical storage and preparation areas are required to have the NFPA diamond with the highest hazard ratings of chemicals in the room posted on all doors.

NFPA fire diamonds are typically found on the chemical label and will determine the highest number posted on fire diamond posted on the chemical storage room door.

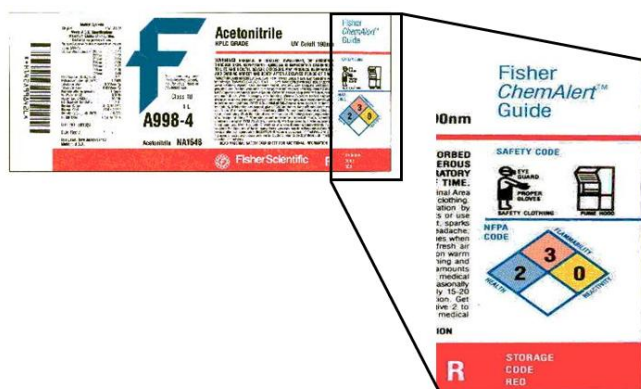

28. Inventory of Chemicals

(These items are mandatory for compliance to Title 14, Regulation 885)

A complete and up-to-date chemical inventory must be available at all times. The following information is required: name of chemical, storage location, date of purchase, and amount on hand. Hazard information is not required in the inventory because the employee can secure that information from the MSDS. The inventory should be ongoing and current at all times. A copy of the inventory must be placed in all MSDS binders. (See Title 14, Regulation 885)

29. Labeling

(These items are mandatory for compliance to Title 14, Regulation 885)

Labeling is required on all chemical containers. All labels must be legible, in English and include chemical/product name and date of purchase. Chemical information related to relevant hazards must also be evident.

30. Material Safety Data Sheets (MSDS)

MSDS for all chemicals, hazardous and non-hazardous, must be kept in a place which is easily accessible. As part of the laboratory safety preparation for an experiment, all appropriate MSDS should be reviewed by the teacher and relevant safety information shared with students. MSDS must be maintained by the Chemical Safety Officer in a chemical binder, a paper copy of which must be maintained in the chemical storage area(s), or in close proximity to the room, and in the principal/administrator's office.



The American National Standards Institute has standardized the MSDS format, which OSHA and other regulatory agencies have also recognized. MSDS's require 16 sections under the ANSI MSDS standard:

1. Chemical or substance identity, CAS number, synonyms, and company contact information, including emergency number.
2. OSHA hazardous ingredient composition and data on components, including exposure limits.
3. Health hazards identification, including acute and chronic levels.
4. First aid measures for exposure.
5. Firefighting measures.
6. Accidental release measures.
7. Handling and storage, including information on explosive risk, flammability, chemical incompatibility and special storage requirements.
8. Exposure controls (OSHA Permissible Exposure Limits or PELs) and personal protection equipment.
9. Physical and chemical properties such as evaporation rate, specific gravity and vapor density.
10. Stability and reactivity.
11. Acute and chronic toxicological information.
12. Ecological information.
13. Disposal considerations – these are suggestions but federal, state and local regulations must be followed.
14. Transport information relative to factors such as flammability, radioactivity and reactivity.
15. Regulations for the chemical.
16. Other information including labeling, disclaimers and references.

SAMPLE MSDS for Sodium Chloride

FLINN SCIENTIFIC INC.

"Your Safer Source for Science Supplies"

Material Safety Data Sheet (MSDS)

MSDS #: 721.00

Revision Date: March 1, 2004

Section 1 — Chemical Product and Company Identification**Sodium Chloride**

Flinn Scientific, Inc. P.O. Box 219 Batavia, IL 60510 (800) 452-1261

CHEMTREC Emergency Phone Number: (800) 424-9300

Section 2 — Composition, Information on Ingredients

Sodium Chloride

Synonym: table salt

CAS#: 7647-14-5

Section 3 — Hazards Identification

White, odorless, crystals.

Very slightly toxic by ingestion. Dust may cause minor irritation to mucous membranes upon inhalation.

FLINN AT-A-GLANCE

Health-0

Flammability-0

Reactivity-0

Exposure-0

Storage-0

0 is low hazard, 3 is high hazard

Section 4 — First Aid Measures

Call a physician, seek medical attention for further treatment, observation and support after first aid.

Inhalation: Remove to fresh air at once. If breathing has stopped give artificial respiration immediately.

Eye: Immediately flush with fresh water for 15 minutes.

External: Wash with soap and water.

Internal: Give large quantities of water. Call a physician or poison control at once.

Section 5 — Fire Fighting Measures

Non combustible.

When heated to decomposition, emits toxic fumes of Cl and Na₂O.**Fire Fighting Instructions:** Use triclass, dry chemical fire extinguisher. Firefighters should wear PPE and SCBA with full facepiece operated in positive mode.**NFPA Code**

None

Established

Section 6 — Accidental Release Measures

Restrict unprotected personnel from area. Sweep up, place in sealed bag or container and dispose. Ventilate area and wash spill site after material pickup is complete. See Sections 8 and 13 for further information.

Section 7 — Handling and Storage

Flinn Suggested Chemical Storage Pattern: Inorganic #2. Store with acetates, halides, sulfates, sulfites, thiosulfates and phosphates. Store in a cool dry place. Keep container tightly closed.

Section 8 — Exposure Controls, Personal Protection

Avoid contact with eyes, skin and clothing. Wear chemical splash goggles, chemical-resistant gloves and chemical-resistant apron.

FLINN SCIENTIFIC INC.

"Your Safer Source for Science Supplies"

Material Safety Data Sheet (MSDS)

Sodium Chloride

MSDS #: 721.00

Revision Date: March 1, 2004

Section 9 — Physical and Chemical Properties

White crystalline powder. Odorless.
 Solubility: Soluble in water and glycerol; slightly in alcohol.
 Formula: NaCl
 Formula Weight: 58.44

Specific Gravity: 2.165
 Melting Point: 801 C
 Boiling Point: 1413 C

Section 10 — Stability and Reactivity

Reacts violently with bromine trifluoride and lithium. Avoid contact with strong oxidizers, acids, bromine.
 Shelf life: Fair, somewhat hygroscopic.

Section 11 — Toxicological Information

Acute effects: Irritant
 Chronic effects: N.A.
 Target organs: N.A.

ORL-RAT LD50: 3000 mg/kg
 IHL-RAT LC50: N.A.
 SKN-RBT LD50: N.A.

N.A. = Not available, not all health aspects of this substance have been fully investigated.

Section 12 — Ecological Information

Data not yet available.

Section 13 — Disposal Considerations

Please consult with state and local regulations.
 Flinn Suggested Disposal Method #26a is one option.

Section 14 — Transport Information

Shipping Name: Not regulated
 Hazard Class: N/A
 UN Number: N/A
 N/A = Not applicable

Section 15 — Regulatory Information

TSCA-listed, EINECS-listed (231-598-3).

Section 16 — Other Information

Consult your copy of the Flinn Scientific Catalog/Reference Manual for additional information about laboratory chemicals. This Material Safety Data Sheet (MSDS) is for guidance and is based upon information and tests believed to be reliable. Flinn Scientific Inc. makes no guarantee of the accuracy or completeness of the data and shall not be liable for any damages relating thereto. The data is offered solely for your consideration, investigation, and verification. Flinn Scientific Inc. assumes no legal responsibility for use or reliance upon this data.

FLINN SCIENTIFIC INC.

"Your Safer Source for Science Supplies"

*Questions on Chemical Disposal
 or Storage?--Call Flinn*

flinn@flinnsci.com www.flinnsci.com
 P.O. Box 219 Batavia IL 60510
 (800) 452-1261 Fax (866) 452-1436



The MSDS binder must be placed in a conspicuous location and be easily accessible in case of an emergency. In most schools, the binder is located near the door between the classroom and the chemical storage area, so it can be accessed from both rooms.

31. Microwave Ovens

Microwave ovens are often used for science activities such as the heating of water. Never use containers with lids on them in a microwave. Never place metallic objects, aluminum foil or metal pots, in a microwave. Students should be instructed on their proper use. Occupants with pacemakers should not work in the proximity of a microwave oven. Proper signage warning of microwave use should be posted outside the laboratory door.

32. Personal Protective Equipment (PPE)

Make sure appropriate personal protective equipment is used, e.g., gloves, apron, chemical splash goggles (safety glasses for projectiles, solids), closed-toe foot protection. The level of PPE required will depend on the nature of the activity and the hazards encountered by students.

33. Pipette Procedure

Use a suction bulb when filling pipettes, never by mouth suction.

34. Planning for Experiments/Demonstrations

Perform experiments or demonstrations prior to assigning the activity to students. Provide verbal and written safety instructions to students before beginning the activity.

35. Refrigerator

Consumable food must not be placed in the same refrigerator as chemicals or biohazard material. Refrigerators used for non-consumable materials should be labeled “**Contents Not For Human Consumption**” or “**For Chemical Storage Only**” or equivalent wording. Use appropriate signage on the doors of both types of refrigerators.



36. Safety Hazards

Teachers should be vigilant in doing safety inspections in the laboratory. Report any existing and potentially hazardous safety violations to the school principal in writing. Do not conduct activities without appropriate and functioning safety equipment.

37. Safety Rules

Safety rules and procedures should be posted in a visible place. Students must receive training in the appropriate safety measures and safety expectations for the laboratory setting.

38. Safety Strategies

- a) Never leave students unsupervised in a laboratory or other instructional area.
- b) Students must read and sign lab safety contracts prior to doing any laboratory activities.
- c) Safety procedures must be reviewed by the teacher with students prior to laboratory work.
- d) Take action to insure student accountability, such as testing of safety procedures.
- e) Never overlook any safety infraction. Direct teacher/student intervention supervision is essential.
- f) Document all safety planning initiatives.
- g) Instruct students in the proper use of all safety equipment.

39. Sharps

Pins, knives, needle probes and scissors should be used with extreme care. Sharps to be discarded should be placed in a separate, rigid container labeled “SHARPS ONLY.”

40. Signage

Have the appropriate signage installed/posted for the following items: exits, eyewash station, fire blanket, fire extinguisher, goggle sanitizer, master shutoffs, safety shower, spill kits and waste containers.



41. Waste Disposal

(These items are mandatory for compliance to Title 14, Regulation 885)

Dispose of all chemical waste properly as noted by the MSDS. Chemicals must never be mixed in sink drains. Sinks should only be used for water and those solutions noted by the instructor. Solid chemicals, filter paper, matches and all other insoluble materials are to be disposed of in the properly labeled waste containers. Cracked or broken glass must be placed in a special container labeled for “**Broken Glass.**”

N.A. = Not available, not all health aspects of this substance have been fully investigated.

Section 12 — Ecological Information

Data not yet available.

Section 13 — Disposal Considerations

Please consult with state and local regulations.
Flinn Suggested Disposal Method #26a is one option.

Section 14 — Transport Information

Shipping Name: Not regulated
Hazard Class: N/A

Waste disposal or items to be recycled should be done on an annual basis. There must be appropriate storage and labeling of all chemicals. Each year, all Delaware public schools are required to inventory their chemical supply and to identify hazardous chemicals that are in need of disposal through a licensed chemical waste disposal company. Each school must submit a signed letter, on official school letterhead, stating whether or not the school has surplus hazardous chemicals in need of disposal. The Delaware Department of Education will then compile the lists and make arrangements to work with the school to have the hazardous surplus chemicals properly disposed of through a licensed chemical disposal company.

(See Title 14, Regulation 885, Section 9.0 *Disposal of Surplus Chemicals*)

C. Personal Protective Equipment (PPE) Requirements:**42. Eye Protective Devices**

(These items are mandatory for compliance to Title 14, Regulation 885)

Eye protection is required by Delaware Law when the process used can cause damage to the eyes or where the protective device can reduce the risk of injury. For example, students in a ninth-grade science class using meter stick for measurement gathering or launching rockets should have safety glasses with side guards at a minimum. If hazardous chemicals such as acids are being used, chemical splash goggles are required.

The general guide is as follows:

Chemical Splash Goggle (indirect vents and ANSI impact standard Z87.1) are required when using hazardous liquids or solids. Eye protection should be hygienically cleaned after each use via UV goggle sanitizer, alcohol wipes or detergent and warm water.

SOURCE OF DANGER TO THE EYES	TYPE OF PROTECTION REQUIRED
a) Caustic or explosive chemicals	Clear goggles, splash proof
b) Explosives, solids or gases	Clear goggles, splash proof
c) Dust producing operations	Clear goggles, splash proof
d) Electric arc welding	Welding helmet
e) Oxy-acetylene welding	Colored goggles or welding helmet
f) Hot liquids and gases	Clear goggles, splash proof
g) Hot solids	Clear or colored goggles
h) Molten metals	Clear or colored goggles
i) Heat treatment or tempering of metals	Clear or colored goggles
j) Glare operations	Colored spectacles or goggles, or welding helmet
k) Shaping of solid materials; chipping, cutting, grinding, milling, sawing, stamping	Clear goggles
l) Repairing or servicing of vehicles when hazard is foreseeable	Clear goggles
m) Spraying and dusting	Clear goggles, splash proof
n) Other similar activity being conducted in the instructional program which risks damage to the eyes	Proper eye protective device

43. Face Protection

Eye protection leaves the face exposed. In certain instances, additional PPE is required beyond eye protection. Face shields protect against most splashes of severely corrosive materials and flying particles. A better solution is to use a fume hood with the sash down as a face barrier.

44. Hand Protection

Gloves are designed for very specific types of situations. One type of glove does not fit all needs. The manufacturer's claims should be reviewed and followed. Gloves should only be used under the conditions for which they were designed.

Types of gloves appropriate for secondary schools include:

- a) Latex/vinyl (microorganisms and biological material – latex is a known allergen for some people)
- b) Butyl rubber (most acids)
- c) Cotton (absorbs perspiration)
- d) Polyvinyl alcohol (organic compounds)
- e) Nitrile rubber (insulates against electricity)
- f) Neoprene (solvents)

Check Material Safety Data Sheets for the appropriate type of glove for maximum protection.

Glove removal is effected by peeling one off of your hand starting at the wrist, moving toward the fingers. Don't allow the surface of the exposed glove to come in contact with the skin. When one glove is removed, use it to peel off the remaining glove.

45. Foot Protection

For laboratory work, students should be wearing closed toed shoes or sneakers. No flip flops or sandals are allowed. This protects the feet from falling objects such as spilled chemicals, weights, rocks, etc.

46. Aprons

Aprons are recommended to protect clothing and skin from spills, splashes, etc. Absorbent type aprons are the best, ensuring that they are the appropriate length.

47. Clothing

The greatest protection comes from wearing long pants and long sleeve shirts/blouses. This again protects the skin. The nature of the activity and the review of the MSDS will dictate clothing guidelines for students.

RESOURCES:

American Chemical Society (<http://www.acs.org>)

American National Standards Institute (<http://www.ansi.org>)

Centers for Disease Control (<http://www.cdc.gov>)

MSDS Online (<http://www.msdsonline.com>)

National Academy Press (<http://www.nap.edu>)

National Fire Protection Association (<http://www.nfpa.org>)

National Safety Council (<http://www.nsc.org>)

National Science Education Leadership Association (<http://www.nsela.org>)

National Science Teachers Association (<http://www.nsta.org>)

Occupational Health and Safety Administration (<http://www.osha.gov>)

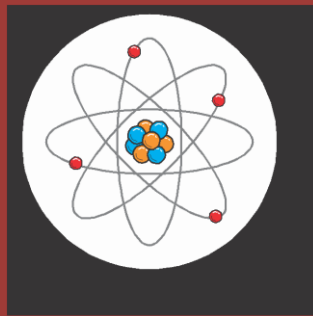

VII. PHYSICS LABORATORY SAFETY SPECIFICATIONS

VII. PHYSICS LABORATORY SAFETY SPECIFICATIONS

A. Electricity

Given the inherent dangers in the laboratory study of electricity, safeguards and safety procedures need to be in place for students and teachers. The following safety procedures are to be used when working with electricity:

1. Know where the master switch is for electricity in the laboratory in case of an emergency.
2. Make students aware of the appropriate use of electricity and dangers of misuse and abuse.
3. When using batteries, always inspect them first for cracks, leaking, etc. Discard in an environmentally appropriate way if any of these conditions occur.
4. When unplugging cords, always pull cords from the plug at the electrical receptacle and never pull the cords from the wire.
5. Use only ground fault interrupt circuits (GFI) protected circuits!
6. Remove all conductive or metallic jewelry before working with electricity.
7. Prevent trip and fall hazards by placing wires away from places where people walk.
8. For routine maintenance like changing bulbs, make sure the device is unplugged before initiating the work.
9. Never open a battery. The contents are corrosive and can be toxic or poisonous.
10. When storing batteries, never allow the terminals to touch or short circuit.
11. Be water phobic when working around electricity. Never use water or have wet hands when dealing with cords, plugs or electrical equipment. Never run a cord near or over a sink.
12. Utility pipes such as water and gas are grounded. Do not touch an electrical circuit and utility pipes at the same time.
13. Never plug damaged electrical equipment into a wall receptacle. This includes frayed wires, missing ground pin and bent plugs.
14. Never overload circuits as they will overheat and cause power outages or fires.

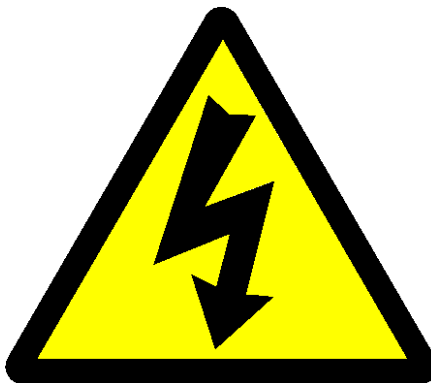

B. Electrostatic Generators:

Electrostatic generators such as Van de Graaff generators are a real attention getter for students in the study of electrostatics. The following safety procedures are to be used when working with generators:

1. The generator should only be operated by and under the direction of the teacher.
2. Electronic circuit or devices such as cell phones, computers and cameras can be permanently damaged by the machine's sparks. Keep them at least 50 feet (15.2 meters) away.
3. Always use a surge protector in line with the generator's power cord.
4. Students with epilepsy, heart or nervous system conditions, or pacemakers should never operate or being the proximity of an electrostatic generator.
5. Never operate the generator near flammable or combustible materials.
6. Never leave the machine operating unattended.

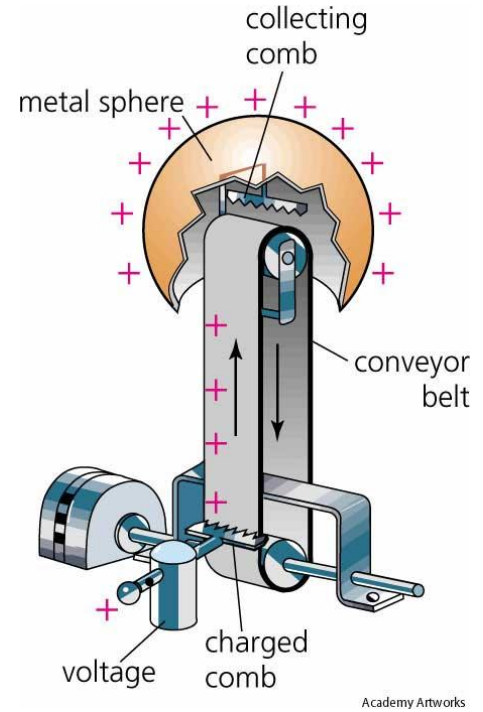
**C. Ionizing Radiation:**

Although the use of ionizing radiation sources in high school science laboratories is not advocated, some physics courses do, in fact, provide these kinds of laboratory activities. When considering having students work with ionizing radiation at the high school level, it is necessary to have planned safety protocols in place. The following safety procedures are to be used when working with radioactive materials:

1. Select only low-level alpha and beta emitters.
2. To prevent accidental entry of radioactive materials into the body, high standards of cleanliness and good housekeeping must be maintained in all laboratories where radioactive materials are present and/or used.
3. Visitors are not allowed without prior approval.
4. Table and bench tops should be of a nonporous, chemical resistant material. Working surfaces shall be covered with absorbent paper regardless of the type of surface.
5. Eating or drinking in laboratories that deal with radioactive materials is unsafe and forbidden. Refrigerators will not be used jointly for foods and radioactive materials.
6. One or more trial runs beforehand with nonradioactive materials are recommended for new procedures and new personnel to test effectiveness of procedures and equipment.

7. Do not work with radioactive materials if there is a break in the skin below the wrist.
8. Always use gloves when handling more than a few hundred counts per minute. Wear protective clothing (lab coats, masks, shoe covers) as needed.
9. When work is completed each person will clean up his own work area and arrange for disposal or proper storage of all radioactive materials and equipment.
10. Wash hands and arms thoroughly before handling any object that goes to the mouth, nose or eyes (e.g., cosmetics, foods). Keep fingernails short and clean.
11. Laboratories shall provide special radioactive waste containers. These shall bear the words "Caution, Radioactive Waste" and a warning to janitors against handling.

D. Mechanics:

The study of mechanics in physics provides many touchstones to everyday applications. However, laboratory activities in this area are not without danger. Students and teachers can be injured if hit by rapidly moving objects or projectiles.

Always use caution when dealing with projectiles, falling objects, moving equipment, exposed belts, powerful permanent magnets, sharps such as Exacto™ knives and razor blades, and springs.

Special attention must be given to the following safety procedures when working with model rockets. Due to the nature of the chemicals in the model rocket engine, it is advisable to gain permission from the school administration prior to purchase and/or use of model rockets in the curriculum. All engines must be stored in a properly equipped chemical storage room.

1. Use only lightweight, nonmetal parts for the nose, body and fins of the rocket.
2. Use only commercially made model rocket engines.
3. To prevent accidental eye injury, place launchers so that the end of the launch rod is above eye level or cap the end of the rod when it is not in use.
4. Always use either safety glasses or safety goggles with an ANSI Z-87.1 rating when launching rockets.
5. Do not tamper with rocket engines or use them for any purposes except those recommended by the manufacturer.
6. Launch rockets outdoors, in an open area and in safe weather conditions with wind speeds no greater than 20 mph.
7. Use a recovery system such as a flame-resistant or fireproof streamer or parachute so that it returns safely and undamaged and can be flown again.
8. Launch rockets with an electrical launch system and electrical motor igniters.
9. The launch system should have a safety interlock in series with the launch switch, and will use a launch switch that returns to the "off" position when released.
10. Use a safe launch distance of at least 15 feet (4.6 meters) away from the launch pad for rockets with up to "D" size engines. Use 30 feet (9.1 meters) when launching larger rockets engines.

11. If the rocket misfires, remove the launcher's safety interlock or disconnect its battery. Wait 60 seconds after the last launch attempt before allowing anyone near the rocket.
12. Launch a rocket from a launch rod, tower, or rail that is pointed within 30 degrees of the vertical to ensure the rocket flies nearly straight up.
13. Use a blast deflector to prevent the engine's exhaust from hitting the ground.
14. Do not launch rockets at targets such as tall buildings, power lines or near airplanes.
15. Never put any flammable or explosive payload in a rocket.
16. Do not attempt to recover rockets from power lines, tall trees or other dangerous places.

E. Nonionizing Radiation – Lasers:

Nonionizing radiation consists of electromagnetic radiation that lacks sufficient energy to ionize matter. These may include the use of lasers, microwaves, infrared radiation and ultraviolet radiation in the physics lab. Nonionizing radiation can cause injury if handled improperly.



The most common nonionizing radiation equipment used in physics laboratories is the laser. Safety specifications vary depending on the class of laser instrument being used. The following general safety specifications provide prudent advice and direction for use in high school physics courses:

1. Before operation, warn all individuals present of the potential hazard.
2. Use the laser away from areas where the uninformed and curious might be attracted by its operation.
3. In conspicuous locations inside and outside the work area and on doors giving access to the area, place hazardous warning signs indicating that a laser is in operation and may be hazardous.
4. Remove all watches and rings before changing or altering the experimental setup. Shiny jewelry can cause hazardous reflections.
5. Practice good housekeeping in the lab to ensure that no device, tool or other reflective material is left in the path of the beam.
6. Before a laser operation, prepare a detailed operating procedure outlining operation.
7. Cover all exposed wiring and glass on the laser with a shield to prevent shock and contain any explosions of the laser materials. Be sure all nonenergized parts of the equipment are grounded.
8. Set up the laser so that the beam path is not at normal eye level, i.e., below 3 feet (0.9 meters) or above 6.5 feet (2 meters).
9. Use shields to prevent strong reflections and the direct beam from going beyond the area needed for the demonstration or experiments.

10. Whenever a laser is operated outside the visible range (such as a CO₂ laser), a warning device must be installed to indicate its operation.
11. A key switch to lock the high voltage supply should be installed.
12. View holograms only with a diverged laser beam. Be sure the diverging lens is firmly attached to the laser.
13. Illuminate the area as brightly as possible to constrict the pupils of the observers.
14. The target of the beam should be a diffuse material capable of absorbing the beam and reflection
15. Do not at any time look into the primary beam of a laser.
16. Do not aim the laser with the eye. Direct reflection can cause eye damage.
17. Do not look at reflections of the beam. These, too, can cause retinal burns.
18. Do not use sunglasses to protect the eyes. If laser safety goggles are used, be certain they are designed for use with the laser being used.
19. Report any afterimage to a doctor, preferably an ophthalmologist who has had experience with retinal burns. Retinal damage is possible.
20. Do not leave a laser unattended.

Table of Laser Classes

Below is a table showing the meaning of the different Classes of Lasers and LEDs according to the current version of EN 60825-1 and IEC 60825-1.

Class 1	Safe.
Class 1M	Safe provided optical instruments are not used.
Class 2	Visible lasers. Safe for accidental exposure (< 0.25 s).
Class 2M	Visible lasers. Safe for accidental exposure (< 0.25 s) providing optical instruments* are not used.
Class 3R	Not safe. Low risk.
Class 3B	Hazardous. Viewing of diffuse reflection** is safe.
Class 4	Hazardous. Viewing of diffuse reflection is also hazardous. Fire risk.



*Optical instruments - binoculars, telescopes, microscopes, magnifying glasses (but not prescription glasses).

**Diffuse reflection - the reflection of radiation from a matt surface such as a wall.

F. Pressurized and Vacuum Systems:

Pressurized gas cylinders can explode. Bell jars can implode. Use only pressurized or evacuated items that are designed for such an activity.

Working with vacuums has the potential of an implosion and the possible hazards of flying glass, splattering chemicals and fire. Potential risks must be carefully considered. Equipment at reduced pressure can be prone to rapid pressure changes forcing liquids through an apparatus.

For safety prevention, adopt the following safety protocols when dealing with pressurized and vacuum systems:

1. Always use safety glasses or goggles with ANSI Z87.1 ratings.
2. Procedures should always be affected inside a hood.
3. Place vacuum apparatus out of harm's way so an accidental hit is minimized. Placement of transparent plastic around the apparatus helps prevent injury from flying glass in case of an explosion.
4. Protect vacuum pumps with cold traps and vent the exhaust into an exhaust hood.
5. Assemble vacuum apparatus in a manner that avoids strain, particularly to the neck of the flask.
6. Do not allow water, solvents and corrosive gases to be drawn into vacuum systems.
7. Avoid putting pressure on a vacuum line to prevent stopcocks from popping out or glass apparatus from exploding.
8. Avoid using mechanical vacuum pumps for distillation or concentration operations when dealing with volatile materials. A water aspirator should be used.

G. Sound:

Usually physics laboratory equipment and activities do not normally produce noise levels requiring use of hearing protection. The OSHA Occupational Noise Standard (29 CFR 1910.95) has established a noise action level of 85 decibels (dBA) averaged over eight hours. Wind tunnels, motors, engines and other laboratory equipment used in physics laboratories have the potential to exceed the action level. Teachers should monitor sound levels and provide hearing protection for themselves and students. It is advised that this be applied even below the action level.

(See also Section XI, Technology and Engineering Laboratory Safety Specifications and Section XIII, Career & Technical Education Laboratory Safety Specifications)

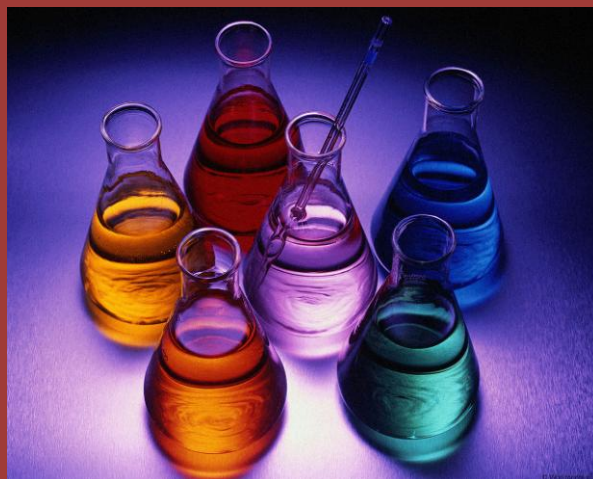

VIII. CHEMISTRY LABORATORY SAFETY SPECIFICATIONS

VIII. CHEMISTRY LABORATORY SAFETY SPECIFICATIONS

A. Hazardous Chemicals:

A hazardous chemical, as defined by the Hazard Communication Standard 29 CFR 1910.1200 (d), is **any chemical that can cause a physical or a health hazard**. This determination is made by the chemical manufacturer. Examples of chemicals causing physical hazards include combustible liquids, compressed gases, explosives, flammables and organic peroxides. Examples of chemicals causing health hazards include carcinogens, corrosives, irritants, sensitizers, toxic agents, reproductive toxins and agents that can damage the eyes, skin, lungs or mucous membranes.



B. Chemical hazards:

Flammables – Flammable liquids and vapors are the most common fire hazard in the laboratory.

Fires need the following three items:

- an oxidizing atmosphere (e.g., air);
- flammable gas or vapor at a concentration within the flammability limits of the substance; and
- an ignition source.

The flash point of a liquid is the lowest temperature at which there are sufficient vapors to form a flammable mixture with air.

The flammable limits/range is the lower and upper vapor concentrations in air at which the vapor will burn.

Carcinogens – Any chemical that can cause cancer. Included are known or suspected carcinogens such as formaldehyde, benzene, carbon tetrachloride, nickel salts, sodium dichromate and sodium chromate. These chemicals should be removed from high school stock rooms and disposed of properly.

Corrosives – Corrosives (e.g., acids, bases, and metallic salts) are chemicals that cause visible destruction of, or irreversible alterations in, living tissue by chemical action at the site of

contact. Corrosive effects may occur to the skin, eyes, respiratory tract and gastrointestinal tract. These chemicals need to be handled using utmost care and safety protocols.

Explosive Substances – Explosive substances are chemicals that decompose at an extremely rapid and violent rate producing large volumes of gas. Ammonium nitrate, isopropyl ether, picric acid and sodium azide are examples of explosives and should be removed by trained experts from the local fire department.

Oxidizers – Oxidizing agents (e.g., nitric acid, oxygen, chlorine, fluorine, hydrogen peroxide, nitrates, nitrites) are chemicals that bring about an oxidation reaction. There is risk of a fire or an explosion when strong oxidizing agents come into contact with easily oxidizable compounds, such as metals, metal hydrides or organics. Because oxidizing agents possess varying degrees of instability, they can be explosively unpredictable.

Sensitizers/Irritants – Sensitizers are chemicals that cause tissue to show an allergic response after repeated exposure, e.g., acetone and zinc chloride. Irritants cause reversible inflammation at the site of contact, e.g., acetic acid and ammonia.

Solvents – Solvents such as acetone, diethyl ether and ethanol have vapor pressures around room temperature and therefore are considered fire hazards. Precautions include storage in a flammable liquid cabinet and usage under a fume hood.

Toxic Chemicals – These are chemicals that affect life processes and can cause death, temporary incapacitation or permanent harm to humans or animals. Toxic chemicals are a danger to the body via absorption, ingestion and inhalation. The Material Safety Data Sheet (MSDS) is a good source to determine the route of entry and measure of toxicity.

Water Reactives – “Water-reactive” means a chemical that reacts with water to release a gas that is either flammable or presents a health hazard. Examples include aluminum powder, calcium carbide, magnesium powder, sodium, potassium and zinc powder.

C. Ordering Chemicals – Safety Procedures:

With the cost of shipping, storing and disposing of chemicals, planning for ordering of chemicals is critical. The following safety procedures are recommended for ordering practices:

1. Estimate the amount of chemicals needed based on inventory.
2. Order only minimal amounts of chemicals. Think “micro-chemistry”!
3. Review MSDS for all new chemicals.
4. Make sure laboratory ventilation system and/or fume hood exhaust will meet the needs for chemical use.
5. Make sure appropriate storage is available: flammable liquid cabinet, acid cabinet, chemical storeroom.

D. Receiving Chemicals:

Safety procedures for receiving shipments of chemicals and their use include the following:

1. Purchase orders should have MSDS requirements stated for all hazardous chemicals purchased.
2. Make sure chemicals are stable and secure for transporting.
3. Only transport chemicals with minimum exposure to building occupants.
4. Transport gas cylinders one at a time using an appropriate hand truck. Do not remove valve cap until the cylinder is in the storage location.
5. Do not accept any hazardous chemicals without an MSDS.
6. Do not accept any hazardous chemicals without proper labeling.

E. Storage of Chemicals:

(These items are mandatory for compliance to Title 14, Regulation 885)

1. Chemical storerooms must be kept under lock and key with limited access to appropriate staff only. No students are to have unsupervised access to the chemical storage room at any time.
2. Chemicals shall not be stored in the classroom for a time period extending beyond the end of the school day. At the end of the day, chemicals are to be secured temporarily in locked storage areas or in the chemical storeroom. All long-term chemical storage must be in a properly equipped chemical storage room.
3. Chemical storerooms must be properly maintained. Roof leaks, should they occur, must be addressed immediately.
4. Chemical storerooms are to have appropriate ventilation (non-re-circulating). It is suggested that the room have a minimum of four room exchanges per hour.
5. Chemical storage rooms must be kept dry and in a temperature range of 50-80 degrees Fahrenheit. Chemicals must not be exposed to direct heat sources, sunlight, or highly variable temperatures.
6. Chemical storerooms must have a chemical spill center or in close proximity to the room.
7. Shelving must be made of finished wood or other chemical resistant material with a front lip approximately 0.75 inch (1.9 cm) to 1 inch (2.54 cm) high. All chemical storage shelving and cabinets are to be securely fastened to the wall or floor to prevent tipping over.
8. Chemicals must be stored using a system that segregates chemicals by hazard levels and/or class (flammable compressed gases, nonflammable compressed gases, flammable liquids, combustible liquids, flammable solids, corrosive acids, corrosive bases, oxidizers, organic peroxides, spontaneously combustible reactives, water reactives, explosives and radioactives).

9. Chemicals are to be organized by compatibility, not alphabetically. Incompatible chemicals are to be stored separately. For example, acetic acid and acetlehyde (acetaldehyde) could be adjacent neighbors on a shelf and are an incompatible pair. Chemicals should only be stored alphabetically within compatible groups.



10. All chemicals must have a date of purchase on the container. Older chemicals should be used first and degradation of older chemicals should be monitored.

11. Flammable liquids must be stored in National Fire Protection Association (NFPA) approved flammable storage containers and cabinets.



12. Flammable and combustible cabinets should not be directly vented. Venting of these cabinets is not recommended or required except for odor control of malodorous materials. The openings on the bottom and top of the cabinets should be sealed with bungs supplied with the cabinet. If the cabinets are to be vented, vent from the bottom openings and makeup air from the top openings [NFPA 30, 4-3.2].

13. Chemicals must be separated into organic and inorganic families, and then into compatible and related groups. Compatible groups can be separated by use of different shelves.

14. Corrosive chemicals such as acids and bases must be stored in separate appropriate chemical storage cabinets.

15. Nitric acid must be stored in a separate cabinet.



NITRIC ACID

16. Lithium, potassium and sodium metals are highly discouraged for use in the high school setting and must be stored under dry mineral oil.

17. All peroxide-forming chemicals (e.g. ethyl ether) must be monitored for age and removed after recommended shelf life.

18. Hazardous liquids should be stored within a secondary containment.

19. No chemicals can be stored above eye level or on the floor. Heavy items must be stored on lower shelves only.

20. Pressurized liquids and gasses must be stored and handled according to current OSHA regulations. Storage bottles must be kept to a small "lecture size" container unless the equipment demands a large tank size (gas chromatograph, MIG welder, etc.).

(See also *Section VI – General Laboratory Safety Specifications, #17 Chemical Storage*)

F. Handling and Using Chemicals:

1. Be aware of safety equipment location in case of a chemical splash or spill including the chemical spill cart.
2. Review MSDS and labels for hazards associated with a chemical before using it.
3. Do not eat or drink in the laboratory.
4. Use the buddy system. Never work alone without another staff member present.
5. Use appropriate personal protective equipment (PPE): chemical splash goggles, hand protections, apron, and closed toed shoes. Flip flops and sandals are inappropriate footwear in the chemistry lab.
6. Never smell, taste or touch chemicals with bare hands.
7. Never return a chemical to original container once it has been removed.
8. Never leave hazardous chemicals or processes unattended.
9. Use good housekeeping practices. Keep areas clean and uncluttered.
10. Always clean up after completing the laboratory activity.
11. Always wash hands with soap and water after completing the laboratory activity.

G. Chemical Disposal:

(These items are mandatory for compliance to Title 14, Regulation 885)

Waste disposal or items to be recycled should be done on an annual basis. There needs to be appropriate storage and labeling of all chemicals.

1. Chemicals are to be disposed of or recycled using environmentally safe procedures.
2. Read MSDS for appropriate chemical disposal.
3. Place used chemicals or products in containers designed and labeled for that purpose.
4. Label the container with appropriate chemical information – content and volume or mass.
5. Keep container closed unless filling.
6. Contact the school's facility department for appropriate disposal instructions.
7. Use only certified and approved chemical waste contractors.

Each year, all Delaware public schools are required to inventory their chemical supply and to identify hazardous chemicals that are in need of disposal through a licensed chemical waste disposal company. Each school must submit a signed letter, on official school letterhead, stating whether or not the school has surplus hazardous chemicals in need of disposal. The Delaware Department of Education will then compile the lists and make arrangements to work with the school to have the hazardous surplus chemicals properly disposed of through a licensed chemical disposal company. [14 DE Admin. Code 885]

H. Chemical Labeling-National Fire Protection Association (NFPA) System:

(These items are mandatory for compliance to Title 14, Regulation 885)

The NFPA system of chemical labeling is characterized by a color coded diamond shaped symbol. It is designed to quickly identify safety hazards of the material and the degree of flammability, level of health and instability hazards. All doors leading to the chemical storage area must have an NFPA diamond posted on them.

For a detailed explanation, see the following websites:

- <http://www.webworldinc.com/wes-con/nfpasign.htm>
- http://www.nmsu.edu/~safety/programs/chem_safety/hazcom_NFPA_labels.htm

I. Chemical Labeling:

(These items are mandatory for compliance to Title 14, Regulation 885)

Hazardous Materials Identification System HMIS Hazardous Materials Identification System (HMIS) was developed by the National Paint & Coatings Association (NPCA) in concert with OSHA’s HazCom Standard. It allows employees to quickly know the type and degree of hazards associated with the chemical being used. However, it is not designed for emergency information like the NFPA system.

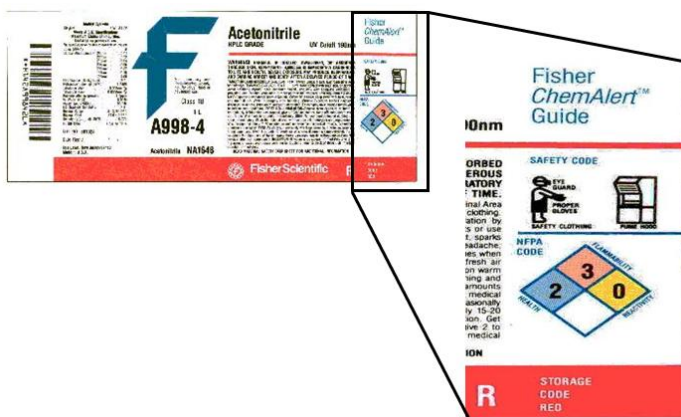

See <http://www.ilpi.com/msds/ref/hmis.html> and <http://www.paint.org/hmis/index.cfm>.

J. Secondary Labels:

(These items are mandatory for compliance to Title 14, Regulation 885)

If chemicals are transferred from a stock bottle into a smaller container, the latter is known as a secondary container. It is a prudent safety practice to label the secondary container. All containers must have the name of the chemical, hazard information, and date on the bottle.

K. Material Safety Data Sheets (MSDS):

The American National Standards Institute has standardized the MSDS format, which OSHA and other regulatory agencies have recognized. MSDS's require 16 sections under the ANSI MSDS standard:

1. Chemical or substance identity, CAS number, synonyms, and company contact information, including emergency number.
2. OSHA hazardous ingredient composition and data on components, including exposure limits.
3. Health hazards identification, including acute and chronic levels.
4. First aid measures for exposure.
5. Firefighting measures.
6. Accidental release measures.
7. Handling and storage, including information on explosive risk, flammability, chemical incompatibility and special storage requirements.
8. Exposure controls (OSHA Permissible Exposure Limits or PELs) and personal protection equipment.
9. Physical and chemical properties such as evaporation rate, specific gravity and vapor density.
10. Stability and reactivity.
11. Acute and chronic toxicological information.
12. Ecological information.
13. Disposal considerations – these are suggestions but federal, state and local regulations must be followed.
14. Transport information relative to factors such as flammability, radioactivity and reactivity.
15. Regulations for the chemical.
16. Other information including labeling, disclaimers and references.



The MSDS binder must be placed in a conspicuous location and be easily accessible in case of an emergency. In most schools, the binder is located near the door between the classroom and the chemical storage area, so it can be accessed from both rooms.

(See also Section VI – *General Laboratory Safety Specifications, #30 Material Safety Data Sheets*)

L. Inventory of Chemicals (Chemical Tracking Systems):

(These items are mandatory for compliance to Title 14, Regulation 885)

Chemical tracking systems are a chemical database which is used to characterize the life of chemicals used in the laboratory. They should cover the history of the chemical. Remember that schools own the chemical from the cradle to the grave! There are various ways to set up these systems from index cards to a computer-based system.

A complete and up-to-date chemical inventory must be available at all times. Hazard information is not required in the inventory because the employee can secure that information from the MSDS. **The inventory shall be ongoing and current at all times.**

Each district and charter school shall prepare an inventory of chemicals by September 15 of each year. A copy of this inventory of chemicals, along with the respective Material Safety Data Sheet (MSDS), shall be kept by the school principal, chief custodian, and the Chemical Safety Officer. Additionally, a copy shall be kept in the Chemical Storage area and with the school nurse or school health manager. [14 DE Admin. Code 885]

The following tracking fields are required by Delaware Title 14, Regulation 885:

1. The name of chemical
2. The amount of the chemicals (in appropriate measurement units)
3. The location where the chemical is stored
4. The date of purchase

The following additional tracking fields are recommended:

1. Chemical hazard of each item [Material Safety Data Sheet (MSDS) information and/or National Fire Protection Association (NFPA) hazard code].
2. Source (supplier).
3. Hazard classification.
4. Required storage conditions.
5. Expiration date.

The chemical inventory should be evaluated in terms of the overall amount of chemicals in storage, the age of chemicals in storage, and the frequency of use of the chemicals in storage. Older chemicals, which have not degraded over time, should be used first OR these chemicals should be properly disposed of through a licensed chemical waste hauler.

M. Centrifuge Operation:

Centrifuges are useful tools in the laboratory but need to be operated safely:

1. Only use a rotor before the manufacturer's expiration or safe-service date.
2. Keep a rotor-use log to prevent overuse. Check the manufacturer's recommendation or specifications as the parameters differ from one machine to another.
3. Clean rotors and buckets with only noncorrosive solutions.
4. Always ensure that loads are evenly balanced before doing a run.
5. Stop the centrifuge immediately if vibration occurs.
6. Never leave the centrifuge unattended.
7. If corrosive or alkaline materials have been run or spilled, be sure to wash affected parts of the centrifuge immediately and allow them to air dry.
8. Never attempt to open the door while the rotor is spinning or attempt to
9. Stop the rotor by hand.
10. Do not attempt to move the centrifuge while it is in operation.

**N. Electricity Hazards:**

Proper grounding of flammable solvent containers and equipment is needed to prevent protection from static electricity and sparks. Dry air or low humidity fosters static electricity dangers. Sources of sparks and discharges include:

1. Hot plate temperature controls.
2. Brush motors.
3. Light and other control switches.
4. Pulling plugs on energized circuits.
5. Motion of plastic or synthetic materials including clothing.
6. Ungrounded metal objects such as screw drivers, metal electrode strips and aluminum foil.

E. Glassware Hazards:

The leading cause of injury incidents in science laboratories usually involves the use of glassware. Borosilicate glassware is recommended for almost all laboratory work. The following procedures are necessary to reduce or eliminate injuries related to glassware in the chemistry laboratory:

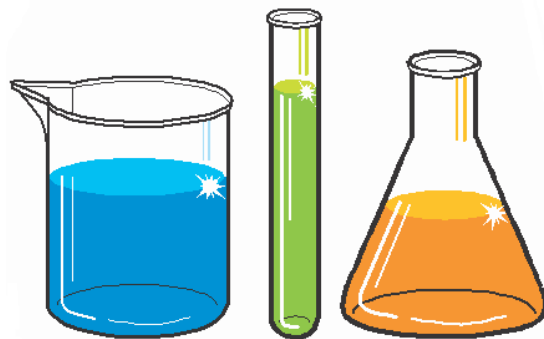

1. Always inspect glassware for cracks and rough edges before using.
2. Discard damaged glassware in appropriate containers.
3. Whenever possible use other types of connections including latex tubing or plastic in lieu of glass.
4. For broken glass, always wear appropriate hand protection, sweep small pieces into a pan and dispose in appropriate containers.
5. Always give hot glass time to cool before handling.
6. When inserting glass tubing into rubber stoppers or corks:
 - a) Wear appropriate hand protection.
 - b) Make sure ends are fire-polished.
 - c) Lubricate the glass tubing with glycerol.
 - d) Hold hands close together to limit motion of the glass.
7. Cutting glassware steps:
 - a) Score the glass tubing 1/3 the way of the circumference with a triangular file using a single stroke.
 - b) Wrap the tubing in paper towels or a cloth to protect the hands.
 - c) Place thumbs on both sides of the score mark opposite the score.
 - d) Push away from the body with even pressure on the tube.
8. Vacuum system glassware steps:
 - a) Use only glassware that can withstand external pressure in the established atmosphere.
 - b) Use Erlenmeyer-type round bottom vessels unless glassware is specifically designed for vacuum work.
 - c) Always wrap vessels with duct tape to reduce glass fragment projectiles in case of an incident.
 - d) Always inspect glassware and connections prior to creating the vacuum.
 - e) Use a positive pressure relief device such as a liquid seal.



IX. BIOLOGY LABORATORY SAFETY SPECIFICATIONS

IX. BIOLOGY LABORATORY SAFETY SPECIFICATIONS

A. Animal Care:

The use of animals in the science classroom or agricultural science classroom can be a very rewarding educational experience. With animals comes humane care and appropriate animal husbandry practices. Abuse, mistreatment and neglect of animals are unacceptable. Observe the following safety precautions when dealing with animals in the laboratory:

1. Provide adequately sized cages.
2. Make sure cages are cleaned on a regular schedule.
3. Cages should be locked and in an environmentally comfortable location.
4. Check with the nurse for student allergies and make accommodations as needed.
5. Use gloves when handling vertebrates.
6. Always wash hands with soap and water after handling animals in the laboratory.
7. Immediately report and have medical examination of animal bites.
8. Should an animal die unexpectedly, a veterinarian should be contacted to evaluate the animal.
9. Never have poisonous animals in the laboratory.
10. Only secure animals from reputable suppliers.
11. Dispose of animal waste and cage materials in a hygienic manner.



B. Biotechnology:

Biotechnology is an exciting relatively new area for course work in high schools. Observe the following safety procedures when working with biotechnology:

1. DNA and microbes should be handled as if they can cause infections.
2. Hand washing hygiene is required before and after laboratory work by washing with antibacterial soap and water.
3. Gloves, chemical splash goggles and aprons are required.
4. Keep fingers away from eyes, nose and mouth.
5. Decontaminate work surfaces before and after laboratory activities and accidental spills.
6. Use only mechanical pipetting. Never use mouth pipetting techniques.
7. Decontaminate all labware such as glassware that was used in laboratory work by soaking in a 10 percent bleach solution for several hours.
8. Prior to disposal of biologicals, destroy all experimental microorganisms.

C. Blood borne Pathogens:

Blood borne pathogens are bacteria, viruses and parasites found in human blood and other body fluids (Other Potentially Infectious Materials, or OPIMs). They can infect and cause disease in humans. The two pathogens recently receiving the greatest attention are the Hepatitis B virus (HBV) and Human Immunodeficiency Virus (HIV). Other pathogens that can also be of concern are herpes, meningitis, tuberculosis, Epstein-Barr virus, Lyme disease, malaria and syphilis, to name a few.

Blood borne pathogens can be transferred by four different ways — direct, indirect, airborne and vector-borne. Direct and indirect are the biggest threat:

Direct — by touching body fluids from an infected person. This includes contact with lesions, open wounds or sores on the skin. Skin lining of the mouth, nose or throat, and eye contact/ invasion, are additional avenues.

Indirect — by touching objects that have touched the blood or another body fluid of an infected person.



Allowing students to do blood work is not a prudent laboratory practice, given the risks involved and therefore is not an allowable practice in Delaware schools. The Centers for Disease Control, OSHA and other regulatory agencies have clear prudent practices for this purpose. Science teachers, supervisors and their employers need to secure safe alternatives to laboratory activities such as human blood typing, cheek cell sampling and urinalysis.

D. Dissections:

Should plant or animal dissections be used in a class for a laboratory or demonstration, the following safety precautions must be observed:

1. Share the MSDS information with students on the preservative prior to doing any dissection activity.
2. Contact the school nurse to determine if any students have allergies relative to specimen preparation chemicals.
3. Always used chemical splash goggles, gloves and aprons when doing dissection work.
4. Review emergency eye-wash procedures for chemical exposure prior to doing dissection work.
5. Always have the specimen completely rinsed prior to dissection to avoid contact with preservative chemicals.
6. Mount specimens on a dissecting pan in lieu of holding the specimen.

7. Use sharps such as dissection scalpels and blades with caution.
8. Cut away from the body — never toward the body.
9. Never remove any dissected parts from the laboratory.
10. Discard dissected parts in appropriate and labeled waste containers.
11. Always wash hands with soap and water after completing the dissection and cleanup.

E. Electrophoresis:

Electrophoresis is a great opportunity for the laboratory study of DNA sequencing and more. However, electrophoresis units tend to operate at relatively high voltages. The following general safety procedures must be addressed in dealing with this technology:



1. Avoid physical contact to unintentional grounding points and conductors like metal, water sources and jewelry.
2. Work should be located on non-conducting benches and floors. Rubber mats can serve as an insulating surface.
3. Use only ground-fault circuit interrupt (GFCI) protected electrical receptacles for power.
4. Locate the equipment in places where wires will not cause a trip and fall hazard.
5. Prior to use of equipment, inspect and correct items such as cracks, leaks and frayed wires.
6. Use caution making any physical contact with the apparatus. A thin layer of moisture acts as an electrical conductor.
7. Some electrophoresis devices have cooling components or apparatus. Do not contact any cooling apparatus with a gel as the tubing can be a current conductor. Always directly supervise the use of the equipment.
8. Exercise caution in working with power supplies that produce high voltage surges when first energized. Should the electrophoresis buffer spill or leak, stop the operation and clean up the spill immediately.
9. Use and post appropriate “Danger – High Voltage” warning signage on power supply and buffer tanks.
10. Upon completion of work, always wait 15 seconds for capacitor discharge after shutting off the power supply before making any disconnections or connections.

F. Field Activities:

Field experiences in biology classes help provide applications to classroom curriculum studies. In preparing for a field experience, the following safety preparations and precautions are to be taken:



1. In planning for field work, review board of education field trip policies.
2. Secure information from parents and the school nurse relative to student medical needs, allergies and contact information.
3. Written permission to obtain help for special needs should also be secured in advance.
4. If laboratory chemicals are used during the field work, MSDS sheets are required on the trip.
5. Communications are essential during field work. Bring a cell phone in touch with the school.
6. West Nile virus, Lyme disease and other insect-borne diseases are real threats. Use appropriate dress (long sleeve shirts, pants, closed-toe shoes or sneakers) and repellents for insects. Make sure that you've informed parents in advance about the use of repellents, so that potential allergies can be avoided.
7. Have a behavior contract that everyone understands, with consequences that everyone will support.
8. Use chemical splash goggles and gloves when working in the field with river, pond or lake water, water testing chemicals and any other materials/activities that may prove hazardous to the eyes.
9. Use good Sun sense by having students and teacher wear long sleeves, long pants, large-brimmed hats, sunglasses and sunscreen (SPF 30 minimum).

G. Heat Sources:**1. Autoclaves/Pressure Cookers**

Autoclaves can be dangerous given high pressures and temperatures. Apply the following safety precautions when using autoclaves:

- a) Inspect the autoclave door and gaskets to make sure they are firmly locked in place.
- b) Post signage on autoclave warning of "hot surfaces, keep away."
- c) Never place combustible or flammable materials near or on the autoclave.
- d) Wear heat-resistant gloves, apron and chemical splash goggles.
- e) Do not leave the autoclave unattended during operation.
- f) Shut down the autoclave should there be any indication of a leak.

Pressure cookers are less expensive than autoclaves and may be useful in simple laboratory sterilization procedures. They can be equally as dangerous as autoclaves at high pressures and temperatures. Apply the following safety precautions when using pressure cookers:

- a) Older pressure cookers have fewer safety features and have the potential to explode if not operating correctly. Always inspect the device to make sure clamps are securely attached, the gasket seal is in place, and the vent tube is clear.
- b) Make sure the vent tube is clear and operational.
- c) Never touch the cooker until it is cooled down.
- d) Never leave the cooker unattended during operation.

2. Bunsen Burners

Bunsen burners can be dangerous as a heat source, given their hot flame. Apply the following safety precautions when using burners:

- a) Make sure hair is tied back.
- b) Always wear chemical splash goggles.
- c) Light the burner at arm's length using an igniter or splint.
- d) Do not operate the burner with acrylic nails.
- e) Never leave the burner unattended.
- f) Do not touch the burner until it has had time to cool off.
- g) Do not operate the burner while igniting it.

3. Hot Plates

Hot plates are a major heat source in biology laboratories. They are easy to operate and less dangerous than gas burners. Apply the following safety precautions when using hot plates:

- a) Always inspect wiring on hot plates before use. Make sure insulation is in place and all prongs are on the plug.
- b) Plug the hot plate into a GFCI protected wall receptacle.
- c) Never touch a hot plate that has been in operation until it cools.
- d) Never tie the cord around a heated hot plate.
- e) Never leave a hot plate unattended.

H. Microbes:

Microbe study in the laboratory requires special precautions given the opportunity of pathogenic bacteria exposure. Apply the following safety precautions when using microbes:

1. Personal protective equipment such as chemical splash goggles, lab coat or apron, and gloves are required during the laboratory activity.
2. Make sure all skin scratches and cuts are covered with bandages.
3. Before and after laboratory activities, wash the work area with disinfectant.
4. Absolutely no food or drink is allowed in the laboratory.
5. Keep sources of potential contamination such as pencils, hands and laboratory equipment away from body orifices such as mouth, ears and nose to prevent potential contamination.
6. Have disinfectant tray available for the discard of contaminated equipment such as pipettes, Petri dishes and more.
7. Should there be an accidental spill of microbial organisms, immediately contain it with dry paper towels. Sterilize the paper towels and disinfect the area of the spill.
8. Report any accidents immediately to the instructor.
9. Only laboratory grade cultures from a reputable scientific supplier should be used in the laboratory. No general survey collections should be cultured given the danger of pathogenic organisms. An effective alternative can be commercially prepared slides.
10. All bacteria cultures and Petri plates should be autoclaved or microwaved prior to disposal.
11. Wash hands with antibacterial soap and water after completing the laboratory work and cleaning up.

I. Microwaves:

Microwave ovens can be used as both a heating source and decontamination device. Apply the following safety precautions when using microwaves:

1. Never operate the microwave oven when empty.
2. Always check the door seal prior to use to make sure it does not have a breach.
3. Persons with pacemakers should not be near the oven when operating.
4. Never place metal objects such as aluminum foil in the oven.
5. Do not put your face near the oven door while operation.
6. Make sure the inside surface of the microwave is clean.
7. Post proper signage warning of microwave use.

J. Plants:

The study of plants is both interesting and relevant to everyday life from food sources, oxygen production and energy sources. However, plants can also produce toxic substances that can put human life in harm's way. Be certain to follow the following safety plan when dealing with plants in the laboratory:

1. Check with the school nurse for potential allergy issues for students. Make accommodations as necessary.
2. Wear safety splash goggles, gloves and aprons when working with plants.
3. Never have poisonous plants or plants producing allergens in the laboratory.
4. Inform about the difference between edible and non-edible plants
5. No plant part should be tasted without specific direction from the teacher.
6. No parts of plants should be burned that have allergen-type oils such as poison ivy and poison oak.
7. Wash hands with soap and water after working with plants.



K. Refrigerator:

The study of biology sometimes requires the use of a refrigerator to store items. Apply the following safety precautions when using refrigerators:

1. Never store food in any refrigerator or freezer used to store chemicals.
2. Refrigerators and freezers should be cleaned out on a regular basis.
3. Containers placed in a refrigerator or freezer should be completely sealed or capped, securely placed and labeled.
4. Avoid capping materials with aluminum foil, corks and glass stoppers.
5. All liquid chemicals should be stored in plastic trays.
6. All specimens should be stored in plastic bags with labels.
7. All items stored are to be appropriately labeled.
8. Review inventory on refrigerator/freezer contents to ensure compatibility of the contents.
9. Store only chemicals in amounts needed over a reasonable amount of time. Each chemical has a shelf-life and decomposition products that could be hazardous.



10. Remember that power outages and technology failure can have an impact on stored contents. Be aware of unusual odors or vapors.
11. Do not use glass beakers as lids for bottles.
12. Do not stack materials too high. Petri dishes/plates should be taped together and placed in a plastic bag.
13. Do not use graduated cylinders or volumetric flasks to store materials.
14. Refrigerators/freezers should be periodically inspected (i.e., at least monthly).
15. Post an up-to-date inventory on the refrigerator door.
16. If potentially infectious material is spilled, clean immediately with a disinfectant agent such as 70 percent isopropyl alcohol. Then, wipe down the area with soap and water.
17. The refrigerator/freezer must be properly grounded and a permanent installation (i.e., no extension cords).
18. The refrigerator/freezer must be located away from lab exits.

(See also Section VI – *General Laboratory Safety Specifications, #35 Refrigerators*)



**X. EARTH & SPACE SCIENCE
LABORATORY
SAFETY SPECIFICATIONS**

X. EARTH & SPACE SCIENCE LABORATORY SAFETY SPECIFICATIONS

A. Astronomy:

Astronomical events such as viewing a solar eclipse are a great opportunity for learning, but safety precautions must be addressed.

1. Never look directly at the sun, including during a solar eclipse. Permanent eye damage is likely to take place.
2. Properly constructed pinhole viewers are a safe way to view the sun.
3. Never view the sun directly through binoculars or telescopes. This can cause blindness.
4. Never use sunglasses or exposed film to view the sun. They do not provide appropriate protection.



B. Geology:

1. Rock and Mineral Study:

Use the following precautions in working with rocks and minerals in the laboratory:

- a) Use appropriate personal protective equipment such as chemical splash goggles, gloves and aprons.
- b) Use a heavy canvas bag when breaking up rock/mineral samples.
- c) Use proper geologic hammer technique.
- d) Never work with radioactive rocks or specimens.



2. Geological Field experience:

Geological field experiences can be exciting and academically rewarding. Apply the following safety precautions when preparing for the field experience and during the field experience:

- a) Secure information relative to medical conditions in preparation for the field activity from the school nurse and parents. Plan for administration of medication as necessary.
- b) Wear appropriate clothing for the weather conditions.
- c) Use Sun sense by wearing appropriate clothing and head gear.
- d) Use appropriate footwear such as boots or sneakers. Flip flops and sandals are unacceptable.
- e) Wear safety glasses or goggles with an ANSI Z87.1 rating. Quarry and cliff type work require use of a safety helmet.
- f) Tetanus shots are suggested.
- g) Rocks and boulders should never be thrown or rolled on the field site. Never touch or try moving rotten trees.
- h) Use caution when hammering rocks.
- i) Use caution when standing near the foot of a cliff.

3. Ultraviolet light

The use of ultraviolet light for mineral study can be dangerous if not done correctly. Apply the following safety precautions when using ultraviolet light:

- a) Protect eyes and skin from exposure of ultraviolet transilluminators.
- b) Wear UV protection rated chemical safety goggles.
- c) Wear long sleeve shirts and lab coat with gloves.
- d) Only use a ground-fault circuit interrupter (GFCI) protected electrical receptacle for the lamp.
- e) Never operate the lamp near water sources.
- f) Never disassemble the lamp when plugged in – this is a high voltage power supply device.

C. Water Studies:**4. Marine Field Trips:**

Marine field trips can be useful activities to expand and apply classroom studies. Apply the following safety precautions when planning marine field trips:

- a) Review weather predictions and prepare appropriately.

- b) Make sure students do not have any open wounds, sores, cuts, etc. prior to going into the water.
- c) Review field hazards and emergency plans with students prior to the start of the activity.
- d) Use foot protection and chemical splash goggles
- e) Be aware of broken glass, fish hooks, rocks and other sharps.
- f) Be watchful for poisonous or stinging marine dwellers like jelly fish, man-of-war.
- g) Always establish boundaries for the area of study.
- h) Provide life jacket for students entering water.
- i) Use sun sense by applying sun screen and appropriate clothing/hat.
- j) One adult should be on beach watch at all times in view of the boundary area.
- k) Remember to bring a cell phone, first aid kit and blanket for emergencies.

5. Stream Tables:

Stream tables can be effective learning tools. Apply the following safety precautions when using stream tables:

- a) Check the table out for leaks, including drain hoses.
- b) Wipe up any spilled water immediately to avoid creating a slip and fall hazard.
- c) Electrical receptacles should be GFCI protected.
- d) Have catch water buckets or receptacles available to catch overflow.

D. Weather Studies:

Weather studies often involve building of weather station equipment. Apply the following safety precautions when planning and conducting weather studies:

1. Safety precautions need to be addressed and in place when using power tools, electrical devices, hand tools and sharp objects to build equipment. Be certain to file down or sand any sharp edges on materials used to construct weather station equipment after being cut. Never use equipment containing mercury such as thermometers or sling psychrometers.
2. Only adults with formal roof walking and fall protection training should be securing equipment on the roof of a building.

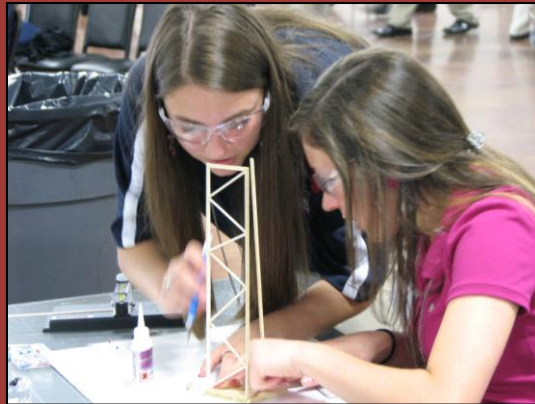

**XI. ENGINEERING & TECHNOLOGY
EDUCATION LABORATORY**

SAFETY SPECIFICATIONS

XI. ENGINEERING & TECHNOLOGY EDUCATION LABORATORY SAFETY SPECIFICATIONS

Personal protective laboratory practices and equipment considerations are those laboratory procedures, practices and equipment that are generally accepted by laboratory health and safety experts as effective, or that the employer can show to be effective, in minimizing the potential for individual exposure to risk.

A. Personal protective laboratory practices include:

1. Wearing eye protection as required by Delaware Law where the process used can cause damage to the eyes or where the protective device can reduce the risk to injury. It is required that the wearing of safety goggles, glasses, or other eye protection when there is a danger of eye injury.
2. Confining long hair so that it is not exposed to machinery and does not interfere with vision. Secure loose clothing and remove jewelry and accessories that may get caught in a machine.
3. Wearing proper footwear at all times. No open-toed shoes, flip-flops, or sandals.
4. Wearing respirators when harmful dusts or fumes exist. Respirator use requires appropriate certification, fit testing, and supervision to insure that there is proper fit, training, and inspection are all taking place.
5. Determining the physical limitations of all students so that they will not be assigned tasks detrimental to their health or physical condition.
6. Wearing ear protection when noise levels are excessive over long periods of time.
7. Ensuring that protective apparel, including safety shoes, aprons, shields, and gloves, are worn properly as required by the nature of the task.
8. Making provisions for the cleaning and sterilizing of respirators, masks, and goggles.
9. Ensuring that head protection is worn in all areas where there is danger of falling and/or flying objects.
10. Ensuring students check with the instructor before performing machine operations.
11. Keeping the work area clear of scrap materials.
12. Setting up the machine for the specific operation.
13. Properly positioning safety guards.
14. Ensure that students focus full attention on the machine operation.
15. Make machine or stock adjustments only after the machine has stopped motion and is turned off.



16. If a problem occurs, stop the machine at a safe point.
17. Ensuring that a machine is never left unattended and running.
18. Removing scrap material that has accumulated after the operation and/or when the machine is not running.

Environmental Considerations: The environmental considerations are the elements in a laboratory setting where safeguards and safety procedures need to be in place for students and teachers. The laboratory is an instructional area where materials are processed to produce products or prototypes. Additionally, the laboratory may use hazardous chemicals on occasion for educational purposes. The following considerations shall be applied toward laboratory environments.

B. Facility Size: The size, shape and arrangement of a facility as well as the location of

passageways, storage and work areas are important factors in establishing a safe working environment. The number of students that can be safely placed into the instructional program may vary with the program requirements and activities. Some programs that involve moving long materials that will be cut and shaped for prototyping activities may require more room per student. Other programs where the students are seated more than being involved with material processing activities may require less area. In general, if the number of students placed in the instructional space is greater than the recommended area, the potential for accidents will increase.



1. The International Technology and Engineering Educators Association (ITEEA, 2010) recommends 180 square feet per student for contemporary technology education laboratories with instructional areas for design, prototyping, fabrication, automation, presentation, office space, and storage (*Delaware minimum is 50 square feet per person*).



2. To estimate the amount of space needed for a contemporary laboratory, determine the number of students per class and multiply by the recommended square feet. Then add 10 to 20% additional space for storage. EXAMPLE: 20 students x 180 sq ft = 3600 sq. ft. + 15% storage = 540 sq ft. **Total = 4140 sq ft.**

C. Lighting: A well lit laboratory includes both natural and artificial lighting. In general a 5:1 ratio of floor space to window area is recommended for natural lighting.

1. Artificial lighting should provide a minimum of 50 to 100 foot candles.
2. In laboratories where detailed work is done, up to 200 foot candles are recommended.
3. A uniform color scheme should be used in the laboratory. Walls should reflect about 60 to 70% of the light that strikes them.

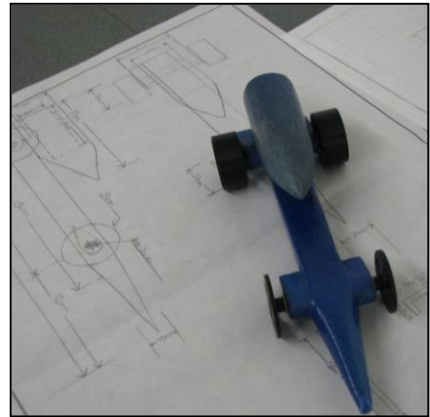

D. Sound: Laboratory equipment and activities may produce noise levels requiring the use of hearing protection. The OSHA Occupational Noise Standard (29 CFR 1910.95) has established a noise action level of 85 decibels (dBA) averaged over eight hours. Wind tunnels, motors, engines, tools / equipment and other laboratory equipment used in laboratories have the potential to exceed the action level. Teachers must monitor sound levels and provide hearing protection for themselves and students. It is advised that this safety practice be applied even below the action level.



E. Safety Zones: In a laboratory, safety zones are established to isolate areas of the laboratory and to provide safe traffic lanes for the students to move through the facility.

Apply the following safety precautions:

1. Major aisles should be 4 feet wide. Other traffic lanes should be three feet wide.
2. A minimum of three feet on each side of stationary power machines is recommended.
3. Laboratories should be arranged by activities involved. Paint, welding, machining and foundry should be isolated away from each other.
4. Machines that exceed 4 feet in height should be placed in close proximity to walls.
5. Attention should be given to the direction of chip throw and kickback. These danger zones should be marked.

- F. Laboratory Ventilation:** Ventilation in a laboratory is critical for a safe and healthy operation. Little or no ventilation can allow the buildup of explosive or flammable vapors, respiratory symptoms and more.

Apply the following safety precautions:

1. Occupied Lab air exchange rates should be six to 10 times an hour based on American Society of Heating, Refrigerating and Air Conditioning Engineers (ASHRAE) handbook or greater than eight air exchanges per NFPA 45. *Contact the director of your school facilities to have the air exchange rate accessed.*
2. Unoccupied lab air exchange rates, including chemical storerooms, should be four times an hour per NFPA 45.
3. Air supplies to labs, storerooms, preparation rooms should never be recycled to any other part of the building, other labs, classrooms and offices.
4. Only conduct experiments that the ventilation system can handle. Otherwise, use a fume hood or select an alternate experiment. Limit occupant exposure.
5. Preventative maintenance programs should be in place to change ventilation filters about four times a year. Filters need to be changed on a quarterly basis.
6. Equipment that may produce a large quantity of dust should have a properly installed dust collection system to reduce the risk of combustible dust.

A good resource for laboratory ventilation is NFPA 45. It addresses required forced air ventilation in science laboratories, including academic labs, and other instructional areas.

- G. Security:** To support instruction and to protect the laboratory from theft, misuse, etc. the following safety precautions should be applied:

1. Tool panels are silhouetted for tools and equipment so that missing items can be easily determined.
2. Supply cabinets are organized so that items have a clearly marked placement. The cabinets should be able to be locked by the instructor to protect contents.
3. Large equipment has lockable switches to prevent their use without the permission of the instructor.
4. Computer security policies are developed and implemented.

H. Recordkeeping :

1. Always keep an adequate record of accidents and report it through proper channels in your district.
2. An analysis of accidents is made for the purpose of corrective action.

I. First Aid: Teachers must report any injury that occurs during a laboratory exercise, however minor, to the school nurse and school administration immediately. Teachers must never administer medication (including topical agents or cough drops) to any student. If the incident is serious enough that the student cannot be moved, the teacher must summon the nurse and keep the area around the student clear. As a general rule, teachers should not administer first aid to students unless the student's life is in danger. This typically also applies to administering adhesive bandages for cuts. All situations requiring first aid and medical treatment must be handled by the nurse. (See local district policy regarding this area).

1. First aid kits that are OSHA compliant, sanitary, properly stocked should be accessible in each laboratory along with a written phone number for the school nurse's office for medical support in case of an incident. Check with the district or charter school policy on employees administering first aid.
2. Teachers and students must be aware of trained personnel in the school and the location of the nearest emergency medical treatment location.
3. Protective gloves must be worn when first aid requires immediate treatment and bodily fluids are present.
4. Eye wash stations and showers must be regularly checked for proper operation.

J. Facility Condition

1. Aisles, machines, benches, and other equipment are arranged to conform to good safety practices.
2. Stairways, aisles, and floors are maintained, clean, dry, and unobstructed with no protruding objects.
3. Walls, windows, and ceilings are clean, maintained in good repair, and free of protrusions.
4. Illumination is safe, sufficient, and well placed.
5. Ventilation and temperature controls are proper for conditions.
6. Fire extinguishers and other necessary fire equipment are properly selected, adequately supplied, properly located, inspected, and periodically recharged as required.
7. Exits are properly identified and illuminated (minimum of 2 exits).
8. Lockers and drawers are clean, free of hazards, and doors kept closed.
9. Staff and students know the procedures for notification of fire and evaluation of premises.
10. Laboratories and workplaces are free from excessive dust, smoke, and airborne toxic materials.
11. Utility lines and shutoffs are properly identified and easily accessible.
12. Stairways, floor openings, and overhead storage areas are properly guarded with rails and toe boards and have the proper clearances.

- K. Color Coding Systems:** Color coding systems are used in a laboratory to indicate both safe and potentially hazardous areas with a laboratory.

Apply the following color coding safety precautions:

1. Red shall be used on fire protection equipment and apparatus, containers for flammable liquids, fire extinguishers, Safety cans and safety signs, emergency stop bars, buttons, or electrical switches on hazardous machines.
2. Orange shall be used as the basic color for designating dangerous parts of machines or energized equipment that may shock, cut, crush or injure. Orange shall be used to emphasize hazards when enclosure doors are open or when gear bolts or other guards around moving equipment are open or removed, exposing unguarded hazards.
3. Yellow shall be the basic color for designating caution and for marking physical hazards from falls, bumps, or collision. It is also used to designate safety zones in aisles and around machines, handrails, low overhead areas, approaches to stairs, and floor areas around open pits. Solid yellow, yellow and black stripes, or checkers (or yellow with suitable contrasting background) should be used interchangeably such that the selected combination will attract the most attention.
4. Green and white shall be used to identify first aid equipment (other than firefighting equipment), safety equipment, and personal protective equipment storage areas.
5. Blue shall be the basic color for designation of caution, limited to warning against the starting, use of, or the movement of equipment under repair or being worked upon.
6. Purple shall designate radiation hazards.
7. Black or White or a combination of these two shall be the basic colors for designation of traffic and housekeeping markings.

L. Housekeeping Practices and Considerations

1. Provide for the storage and daily removal of all sawdust, metal cuttings, rags, and other waste materials.
2. Provide properly marked boxes, bins, or containers for various kinds of scrap stock and rags.
3. Utilize sturdy racks and bins for material storage, arranged to keep material from falling on students and to avoid injuries from protruding objects.
4. Employ a standard procedure to keep floors free of oil, water, and foreign material.
5. Provide for the cleaning of equipment and facilities after each use.
6. Provide regular custodial service in addition to end of class cleanup.
7. Prohibit the use of compressed air to clean clothing, equipment, and work areas.
8. Keep walkways and work areas free of all obstructions.
9. Floor surfaces must be maintained in a “nonskid” condition.
10. Tools and materials are stored orderly and safely.
11. File cabinets and other tall cabinets are required to be anchored.

Tool and Powered Equipment Considerations: Injuries in Engineering and Technology Education laboratories can occur with the improper use of tools and equipment. Training and supervision is essential for the safe use of tools and equipment. The following considerations should be applied toward tools and equipment.

M. Power equipment and machines:

1. All equipment should be operated in accordance with specifications as stated in the owner’s manual.
2. All students should have knowledge of operation procedures for each tool or machine to prepare, operate and terminate a procedure.
3. Each student must have the motor skills needed to perform a tool or machine operation safely.
4. Machines and apparatus are arranged so that operators are protected from hazards of other machines or passing individuals.
5. Point of operation zones are properly identified and guarded.
6. Permanent enclosure guards properly protect pulleys, gears, and belts.
7. Guards are removed only for repair purposes and then replaced immediately.
8. Equipment control switches for each machine are easily available to the operator.
9. Machines are turned off when the instructor is out of the room and/or if the machine is unattended. Proper cleaning equipment is used (avoid air for cleaning purposes).
10. Nonskid areas are maintained around dangerous equipment.
11. A preventive maintenance program is established for all equipment.
12. Cutting tools are kept sharp, clean, and in safe working order.
13. All hoisting devices are maintained in a safe operating condition and specified load ratings are easily identified.
14. Machines that are defective or being repaired are clearly marked and made inoperable by locking out the machine power switch.
15. Machines and apparatus are marked with proper color code.
16. Equipment cords and adapters are maintained in a safe working condition.
17. Adjustment and repair of any machine is restricted to experienced persons.
18. Ladders are maintained and stored properly.
19. Machines designated for fixed location are securely anchored.
20. The appropriate personal protective equipment selected to be worn must at minimum match the specification for protection for the tool, equipment, or task.

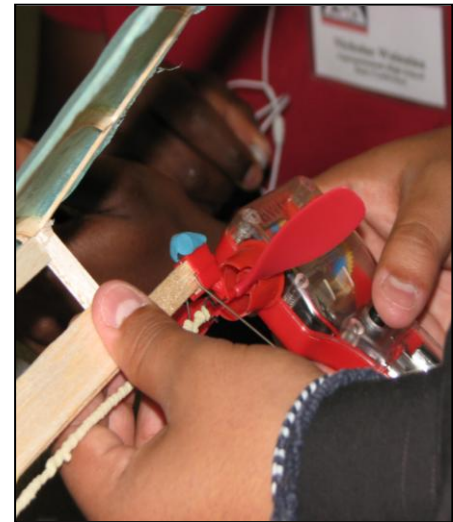

N. Hand tools:

1. Instruct students to select the right tools for each job.
2. Establish regular tool inspection procedures to ensure tools are maintained in safe condition.
3. Instruct students in the correct use of tools for each job.
4. Provide proper storage facilities.
5. Do not lay tools on operating machinery or equipment.
6. Keep tools out of aisles and working spaces where they may become tripping hazards.
7. Do not put sharp objects or tools in pockets. This could result in cuts or being stabbed.

Resources:

International Technology and Engineering Educators Association (2010). Centers of Applied Learning Facilities Planning Guide.

International Technology Education Association (2006). Safety System Design for Technology Education.

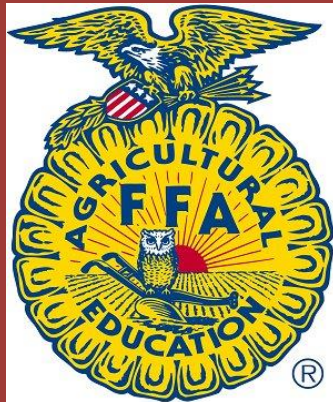

XII. AGRICULTURAL SCIENCE LABORATORY SAFETY SPECIFICATIONS

XII. AGRICULTURAL SCIENCE LABORATORY SAFETY SPECIFICATIONS

A. Agricultural Education Facilities

Since agricultural education programs include hands-on and laboratory activities within the classroom, the agriculture classroom should be larger than the standard classroom size. Classrooms that do not provide a safe working space must either be expanded, or the class size limited to meet these standards.

The facilities for agricultural education must be accessible to all populations, clean, attractive, safe, healthy, adequate, and appropriate for the instructional program being offered. Special consideration shall be given to handicapped students as well as providing for the special needs of co-ed classes.



Physical facilities for agricultural education programs shall include adequate space and utilities in classrooms, laboratories, and shop areas, which provide for safe and orderly instruction. Both instructional and non-instructional areas, including storage areas, restrooms and offices, shall be adequate for the number of students and staff using such areas.

When possible the following guidelines should be followed to ensure adequate space.

Facility type and space allocation recommendations:

Classroom	25 square feet per student
Ag Mechanics laboratory	150 square feet per student
Greenhouse	70 square feet per student
Agribusiness lab with computers	15 square feet per student
Lab storage	320 square feet
Teacher office	120 square feet
Classroom Storage	120 square feet

Additional Facility Considerations:

- Locker/storage space for student lab clothes and supplies
- Clean-up/wash basin area
- Bathroom facilities for male and female students

The teaching load (student-teacher ratio) will vary with the program, depending upon the number/kinds of students to be served, the specific skills to be taught, the size of the facility, and the methods of instruction. Reasonable enrollment limits must be maintained to ensure that program objectives may be met in an efficient and effective manner. For safety reasons, classes involving laboratory or shop activities be limited in enrollment to a size appropriate for the instruction.

B. Agricultural Safety Training

Agriculture instructors shall ensure that safety training is incorporated into the instructional content of all areas of the training program; safety instruction should include equipment safety, chemical safety, fire safety, and blood borne pathogens safety.

Safety tests specific to courses shall be given and kept on file for all students.

A safety inspection must be conducted at least annually of the facilities including all lab areas, equipment, and approved storage for hazardous materials, for all phases of the agriculture program by district and/or school personnel. Inspections may be conducted by the school or district Chemical Safety Officer.

Due to the nature of agriculture training and related employment, student safety and safety training are considered essential to quality program operations. Schools offering agriculture programs shall ensure that safety features in the instructional facilities and equipment are properly implemented and maintained. In addition, adequate lighting, heat, and ventilation shall be provided to ensure a safe and healthy learning environment.



(Adapted from: Kansas Department of Education. (2004). *Agricultural Education Program Standards*.)

C. Chemical Safety:

The agricultural education laboratory provides students with a wide variety of chemical safety hazards. All agricultural education laboratories must follow the mandatory specifications for chemical storage outlined in Section VI – *General Laboratory Safety Specifications*.

Pesticides, paints, fertilizers, and other hazardous materials must be stored and used appropriately. In general, students do not have access to chemical storage areas; however, if student management of chemicals is part of the curriculum, supervised access is permitted. Proper safety equipment, including personal protective equipment (PPE), must be available to staff and students at all times when they are exposed to hazardous chemicals.

D. Storage of Chemicals:

(These items are mandatory for compliance to Title 14, Regulation 885)

1. Chemical storerooms must be kept under lock and key with limited access to appropriate staff only. No students are to have unsupervised access to the chemical storage room at any time.
2. Chemicals shall not be stored in the classroom for a time period extending beyond the end of the school day. At the end of the day, chemicals are to be secured temporarily in locked storage areas or in the chemical storeroom. All long-term chemical storage must be in a properly equipped chemical storage room.
3. Chemical storerooms must be properly maintained. Roof leaks, should they occur, must be addressed immediately.
4. Chemical storerooms are to have appropriate ventilation (non-re-circulating). It is suggested that the room have a minimum of four room exchanges per hour.
5. Chemical storage rooms must be kept dry and in a temperature range of 50-80 degrees Fahrenheit. Chemicals must not be exposed to direct heat sources, sunlight, or highly variable temperatures.
6. Chemical storerooms must have a chemical spill center.
7. Shelving must be made of finished wood or other chemical resistant material with a front lip approximately 0.75 inch (1.9 cm) to 1 inch (2.54 cm) high. All chemical storage shelving and cabinets are to be securely fastened to the wall or floor to prevent tipping over.
8. Chemicals must be stored using a system that segregates chemicals by hazard levels and/or class (flammable compressed gases, nonflammable



compressed gases, flammable liquids, combustible liquids, flammable solids, corrosive acids, corrosive bases, oxidizers, organic peroxides, spontaneously combustible reactives, water reactives, explosives and radioactives.

9. Chemicals are to be organized by compatibility, not alphabetically. Incompatible chemicals are to be stored separately. For example, acetic acid and acetaldehyde (acetaldehyde) could be adjacent neighbors on a shelf and are an incompatible pair. Chemicals should only be stored alphabetically within compatible groups.
10. All chemicals must have a date of purchase on the container. Older chemicals should be used first and degradation of older chemicals should be monitored.
11. Flammable liquids must be stored in National Fire Protection Association (NFPA) approved flammable storage containers and cabinets.
12. Flammable and combustible cabinets should not be directly vented. Venting of these cabinets is not recommended or required except for odor control of malodorous materials. The openings on the bottom and top of the cabinets should be sealed with bungs supplied with the cabinet. If the cabinets are to be vented, vent from the bottom openings and makeup air from the top openings [NFPA 30, 4-3.2].
13. Chemicals must be separated into organic and inorganic families, and then into compatible and related groups. Compatible groups can be separated by use of different shelves.
14. Corrosive chemicals such as acids and bases must be stored in separate appropriate chemical storage cabinets.
15. Nitric acid must be stored in a separate cabinet.
16. Lithium, potassium and sodium metals are highly discouraged for use in the high school setting and must be stored under dry mineral oil.
17. All peroxide-forming chemicals (e.g. ethyl ether) must be monitored for age and removed after recommended shelf life.
18. Hazardous liquids should be stored within a secondary containment.
19. No chemicals can be stored above eye level or on the floor. Heavy items must be stored on lower shelves only.
20. Pressurized liquids and gasses must be stored and handled according to current OSHA regulations. Storage bottles must be kept to a small "lecture size" container unless the equipment demands a large tank size (gas chromatograph, MIG welder, etc.).



NITRIC ACID

(See also Section VI – *General Laboratory Safety Specifications, #17 Chemical Storage*)

E. Chemical Disposal:

(These items are mandatory for compliance to Title 14, Regulation 885)

Waste disposal or items to be recycled should be done on an annual basis. There needs to be appropriate storage and labeling of all chemicals.

1. Chemicals are to be disposed of or recycled using environmentally safe procedures.
2. Read MSDS for appropriate chemical disposal.
3. Place used chemicals or products in containers designed and labeled for that purpose.
4. Label the container with appropriate chemical information – content and volume or mass.
5. Keep container closed unless filling.
6. Contact the school's facility department for appropriate disposal instructions.
7. Use only certified and approved chemical waste contractors.

Each year, all Delaware public schools are required to inventory their chemical supply and to identify hazardous chemicals that are in need of disposal through a licensed chemical waste disposal company. Each school must submit a signed letter, on official school letterhead, stating whether or not the school has surplus hazardous chemicals in need of disposal. The Delaware Department of Education will then compile the lists and make arrangements to work with the school to have the hazardous surplus chemicals properly disposed of through a licensed chemical disposal company. [14 DE Admin. Code 885]

F. Chemical Labeling-National Fire Protection Association (NFPA) System:

The NFPA system of chemical labeling is characterized by a color coded diamond shaped symbol. It is designed to quickly identify safety hazards of the material and the degree of flammability, level of health and instability hazards. All doors leading to chemical storage areas must have an NFPA diamond posted on them.

For a detailed explanation, see the following websites:

<http://www.webworldinc.com/wes-con/nfpasign.htm>

http://www.nmsu.edu/~safety/programs/chem_safety/hazcom_NFPA_labels.htm

G. Material Safety Data Sheets (MSDS):

The MSDS binder must be placed in a conspicuous location and be easily accessible in case of an emergency. In most schools, the binder is located near the door between the classroom and the chemical storage area, so it can be accessed from both rooms.



(See also Section VI – *General Laboratory Safety Specifications, #30 Material Safety Data Sheets*)

H. Inventory of Chemicals (Chemical Tracking Systems):

(These items are mandatory for compliance to Title 14, Regulation 885)

Chemical tracking systems are a chemical database which is used to characterize the life of chemicals used in the laboratory. They should cover the history of the chemical. Remember that schools own the chemical from the cradle to the grave! There are various ways to set up these systems from index cards to a computer-based system.

A complete and up-to-date chemical inventory must be available at all times. Hazard information is not required in the inventory because the employee can secure that information from the MSDS. **The inventory shall be ongoing and current at all times.**

Each district and charter school shall prepare an inventory of chemicals by September 15 of each year. A copy of this inventory of chemicals, along with the respective Material Safety Data Sheet (MSDS), shall be kept by the school principal, chief custodian, and the Chemical Safety Officer. Additionally, a copy shall be kept in the Chemical Storage area and with the school nurse or school health manager. [14 DE Admin. Code 885]

The following tracking fields are required by Delaware Title 14, Regulation 885:

1. The name of chemical
2. The amount of the chemicals (in appropriate measurement units)
3. The location where the chemical is stored
4. The date of purchase

The following additional tracking fields are recommended:

1. Chemical hazard of each item [Material Safety Data Sheet (MSDS) information and/or National Fire Protection Association (NFPA) hazard code].
2. Source (supplier).
3. Hazard classification.
4. Required storage conditions.
5. Expiration date.

The chemical inventory should be evaluated in terms of the overall amount of chemicals in storage, the age of chemicals in storage, and the frequency of use of the chemicals in storage. Older chemicals, which have not degraded over time, should be used first OR these chemicals should be properly disposed of through a licensed chemical waste hauler.

I. Animal Care:

The use of animals in the science classroom or agricultural science classroom can be a very rewarding educational experience. With animals comes humane care and appropriate animal husbandry practices. Abuse, mistreatment and neglect of animals are unacceptable. Observe the following safety precautions when dealing with animals in the laboratory:

1. Provide adequately sized cages.
2. Make sure cages are cleaned on a regular schedule.
3. Cages should be locked and in an environmentally comfortable location.
4. Check with the nurse for student allergies and make accommodations as needed.
5. Use gloves when handling vertebrates.
6. Always wash hands with soap and water after handling animals in the laboratory.
7. Immediately report and have medical examination of animal bites.
8. Should an animal die unexpectedly, a veterinarian should be contacted to evaluate the animal.
9. Never have poisonous animals in the laboratory.
10. Only secure animals from reputable suppliers.
11. Dispose of animal waste and cage materials in a hygienic manner.

**J. Plants:**

The study of plants is both interesting and relevant to everyday life from food sources, oxygen production and energy sources. However, plants can also produce toxic substances that can put human life in harm's way. Be certain to follow the following safety plan when dealing with plants in the laboratory:

1. Check with the school nurse for potential allergy issues for students. Make accommodations as necessary.
2. Wear safety splash goggles, gloves and aprons when working with plants.
3. Never have poisonous plants or plants producing allergens in the laboratory.
4. Inform about the difference between edible and non-edible plants
5. No plant part should be tasted without specific direction from the teacher.
6. No parts of plants should be burned that have allergen-type oils such as poison ivy and poison oak.
7. Wash hands with soap and water after working with plants.



K Field Activities:

Field experiences in agriculture studies help provide applications to classroom curriculum studies. In preparing for a field experience, the following safety preparations and precautions are to be taken:



1. In planning for field work, review board of education field trip policies.
2. Secure information from parents and the school nurse relative to student medical needs, allergies and contact information.
3. Written permission to obtain help for special needs should also be secured in advance.
4. If laboratory chemicals are used during the field work, MSDS sheets are required on the trip.
5. Communications are essential during field work. Bring a cell phone in touch with the school.
6. West Nile virus, Lyme disease and other insect-borne diseases are real threats. Use appropriate dress (long sleeve shirts, pants, closed-toe shoes or sneakers) and repellents for insects. Make sure that you've informed parents in advance about the use of repellents, so that potential allergies can be avoided.
7. Have a behavior contract that everyone understands, with consequences that everyone will support.
8. Use chemical splash goggles and gloves when working in the field with river, pond or lake water, water testing chemicals and any other materials/activities that may prove hazardous to the eyes.
9. Use good Sun sense by having students and teacher wear long sleeves, long pants, large-brimmed hats, sunglasses and sunscreen (SPF 30 minimum).



Prince George's County Public Schools

XIII. CAREER & TECHNICAL EDUCATION LABORATORY SAFETY SPECIFICATIONS

XIII. CAREER & TECHNICAL EDUCATION LABORATORY SAFETY SPECIFICATIONS

The Career and Technical Education (CTE) areas encompass a wide variety of student programs, each with their own unique safety challenges. In most cases, the CTE areas self-impose industry standard and/or OSHA standard safety practices so that students are adequately prepared for the workforce. Hazardous chemicals are inherently part of the educational programs in the CTE area. If the chemical (i.e. oil, antifreeze, paint, etc.) is used in accordance to the manufacturer's instructions, it is exempt from further chemical storage and management requirements provided that the manufacturer's safety and storage requirement have been met. (See also Section VI – *General Laboratory Safety Specifications*, #17 *Chemical Storage*)

Student use of chemicals and student access to chemical storage areas must always be supervised and teachers must ensure that the level of access is appropriate for the specific CTE curriculum. Use section VI – *General Laboratory Safety Specifications* and the manufacturer's safety instructions as a resource to determine how to safely manage the chemicals used in the CTE laboratory/workplace.

A. General Safety Practices

Personal protective laboratory practices and equipment considerations are those laboratory procedures, practices and equipment that are generally accepted by laboratory health and safety experts as effective, or that the employer can show to be effective, in minimizing the potential for individual exposure to risk.

1. BODY MECHANICS

- a) Use proper muscle groups and distribute the workload.
- b) Both hands are used to pick up heavier objects.
- c) Lifting heavy objects alone is avoided. Help is requested.
- d) Pushing is preferred to pulling.
- e) Leg muscles are used to lift heavy objects rather than back muscles.
- f) Bending and unnecessary twisting of the body for any length of time is avoided.
- g) Work is done at the proper level.
- h) Two people carry long pieces of materials.
- i) Do not lift heavy loads above shoulder level.

2. PERSONAL PROTECTION

- a) Confine long hair so that it is not exposed to machinery and does not interfere with vision.
- b) Require the wearing of safety goggles, glasses, or other eye protection when there is a danger of eye injury.
- c) Provide respirators for use where harmful dusts or fumes exist. Respirator use requires appropriate certification, fit testing, and supervision to insure that there is proper fit, training, and inspection are all taking place.
- d) Determine the physical defects and limitations of all students so that they will not be assigned tasks detrimental to their health or physical condition.
- e) Prohibit the wearing of loose clothing in the laboratory and shop areas.
- f) Require students to remove rings and other jewelry while working in the laboratory and shop areas.
- g) Where noise levels are excessive over long periods of time, ear protection should be worn.
- h) Protective apparel, including safety shoes, aprons, shields, and gloves, are worn properly as required by the nature of the task.
- i) Provisions are made for cleaning and sterilizing respirators, masks, and goggles.
- j) Head protection is worn in all areas where there is danger of falling and/or flying objects.



Environmental Considerations: The environmental considerations are the elements in a laboratory setting where safeguards and safety procedures need to be in place for students and teachers. The laboratory is an instructional area where materials are processed to produce products or prototypes. Additionally, the laboratory may use hazardous chemicals on occasion for educational purposes. The following considerations shall be applied toward laboratory environments.

3. FACILITY CONDITION

- a) Aisles, machines, benches, and other equipment are arranged to conform to good safety practices.
- b) Stairways, aisles, and floors are maintained, clean, dry, and unobstructed with no protruding objects.
- c) Walls, windows, and ceilings are clean, maintained in good repair, and free of protrusions.

- d) Illumination is safe, sufficient, and well placed.
- e) Ventilation and temperature controls are proper for conditions.
- f) Fire extinguishers and other necessary fire equipment are properly selected, adequately supplied, properly located, inspected, and periodically recharged as required.
- g) Exits are properly identified and illuminated.
- h) Lockers and drawers are clean, free of hazards, and doors kept closed.
- i) Personnel know the procedures for notification of fire and evaluation of premises.
- j) Laboratories and workplaces are free from excessive dust, smoke, and airborne toxic materials.
- k) Utility lines and shutoffs are properly identified.
- l) Stairways, floor openings, and overhead storage areas are properly guarded with rails and toe boards and have the proper clearances.

4. FACILITY SIZE

The size, shape and arrangement of a facility as well as the location of passageways, storage and work areas are important factors in establishing a safe working environment. The number of students that can be safely placed into the instructional program may vary with the program requirements and activities. Some programs that involve moving long materials that will be cut and shaped for prototyping activities may require more room per student. Other programs where the students are seated more than being involved with material processing activities may require less area. In general, if the number of students placed in the instructional space is greater than the recommended area, the potential for accidents will increase.

5. HOUSEKEEPING PRACTICES

- a) Provide for the storage and daily removal of all sawdust, metal cuttings, rags, and other waste materials.
- b) Provide properly marked boxes, bins, or containers for various kinds of scrap stock and rags.
- c) Utilize sturdy racks and bins for material storage, arranged to keep material from falling on students and to avoid injuries from protruding objects.
- d) Employ a standard procedure to keep floors free of oil, water, and foreign material.
- e) Provide for the cleaning of equipment and facilities after each use.
- f) Provide regular custodial service in addition to end of class cleanup.
- g) Prohibit the use of compressed air to clean clothing, equipment, and work areas.
- h) Keep walkways and work areas free of all obstructions.
- i) Floor surfaces must be maintained in a “nonskid” condition.
- j) Tools and materials are stored orderly and safely.
- k) File cabinets and other tall cabinets are required to be anchored.

Tool and Powered Equipment Considerations: Injuries in Engineering and Technology Education laboratories can occur with the improper use of tools and equipment. Training and supervision is essential for the safe use of tools and equipment. The following considerations should be applied toward tools and equipment.

6. EQUIPMENT

- a) All equipment should be operated in accordance with specifications as stated in the owner's manual.
- b) Machines and apparatus are arranged so that operators are protected from hazards of other machines or passing individuals.
- c) Point of operation zones are properly identified and guarded.
- d) Permanent enclosure guards properly protect pulleys, gears, and belts.
- e) Guards are removed only for repair purposes and then replaced immediately.
- f) Equipment control switches for each machine are easily available to the operator.
- g) Machines are turned off when the instructor is out of the room and/or if the machine is unattended. Proper cleaning equipment is used (avoid air for cleaning purposes).
- h) Nonskid areas are maintained around dangerous equipment.
- i) A preventive maintenance program is established for all equipment.
- j) Machines are guarded to comply with WISHA code.
- k) Cutting tools are kept sharp, clean, and in safe working order.
- l) All hoisting devices are maintained in a safe operating condition and specified load ratings are easily identified.
- m) Machines that are defective or being repaired are clearly marked and made inoperable by locking out the machine power switch.
- n) Machines and apparatus are marked with proper color code.
- o) Equipment cords and adapters are maintained in a safe working condition.
- p) Adjustment and repair of any machine is restricted to experienced persons.
- q) Ladders are maintained and stored properly.
- r) Machines designated for fixed location are securely anchored.

6. SAFETY ZONES

In a laboratory, safety zones are established to isolate areas of the laboratory and to provide safe traffic lanes for the students to move through the facility.

- a) Major aisles should be 4 feet wide. Other traffic lanes should be three feet wide.
- b) A minimum of three feet on each side of stationary power machines is recommended.
- c) Laboratories should be arranged by activities involved. Paint, welding, machining and foundry should be isolated away from each other.
- d) Machines that exceed 4 feet in height should be placed in close proximity to walls.
- e) Attention should be given to the direction of chip throw and kickback. These danger zones should be marked.

7. RECORDKEEPING

- a) Always keep an adequate record of accidents and report it through proper channels in your district.
- b) An analysis of accidents is made for the purpose of corrective action.

8. HAND TOOLS

- a) Instruct students to select the right tools for each job.
- b) Establish regular tool inspection procedures to ensure tools are maintained in safe condition.
- c) Instruct students in the correct use of tools for each job.
- d) Provide proper storage facilities.
- e) Do not lay tools on operating machinery or equipment.
- f) Keep tools out of aisles and working spaces where they may become tripping hazards.
- g) Do not put sharp objects or tools in pockets. This could result in cuts or being stabbed.

9. SCAFFOLDS

- a) The footing or anchorage for scaffolding is sound, rigid, and capable of carrying the maximum intended load without settling or displacement.
- b) Unstable objects such as barrels, boxes, loose bricks, or concrete blocks cannot be used to support scaffold or planks.
- c) No scaffold will be erected, moved, dismantled, or altered except under the supervision of the instructor.
- d) Guard rails and toe boards will be installed on all open sides of platforms more than 10 feet above the ground or floor.
- e) Scaffolds 4–10 feet, having a minimum horizontal of less than 45 inches in either direction, will have standard guardrails installed on all open sides and ends of the platform.
- f) Scaffolds and their components will be capable of supporting without failure four times the maximum intended load.
- g) All planking of platforms will be overlapped a minimum of 12 inches or secured from movement.
- h) An access ladder or equivalent safe access will be provided.
- i) Scaffold planking will extend over their end supports not less than 6 inches or more than 12 inches.
- j) The use of shore or lean-to scaffolds is prohibited.
- k) The poles, legs, or uprights of a scaffold will be plumb and securely and rigidly braced to prevent swaying and displacement.



B. Color Coding Systems

10. Color Coding Systems: Color coding systems are used in a laboratory to indicate both safe and potentially hazardous areas with a laboratory.

Apply the following color coding safety precautions:

- a) Red shall be used on fire protection equipment and apparatus, containers for flammable liquids, fire extinguishers, Safety cans and safety signs, emergency stop bars, buttons, or electrical switches on hazardous machines.
- b) Orange shall be used as the basic color for designating dangerous parts of machines or energized equipment that may shock, cut, crush or injure. Orange shall be used to emphasize hazards when enclosure doors are open or when gear bolts or other guards around moving equipment are open or removed, exposing unguarded hazards.
- c) Yellow shall be the basic color for designating caution and for marking physical hazards from falls, bumps, or collision. It is also used to designate safety zones in aisles and around machines, handrails, low overhead areas, approaches to stairs, and floor areas around open pits. Solid yellow, yellow and black stripes, or checkers (or yellow with suitable contrasting background) should be used interchangeably such that the selected combination will attract the most attention.
- d) Green and white shall be used to identify first aid equipment (other than firefighting equipment), safety equipment, and personal protective equipment storage areas.
- e) Blue shall be the basic color for designation of caution, limited to warning against the starting, use of, or the movement of equipment under repair or being worked upon.
- f) Purple shall designate radiation hazards.
- g) Black or White or a combination of these two shall be the basic colors for designation of traffic and housekeeping markings.

C. Noise Control

The ability to hear is a precious gift. Without it, it is difficult to lead a fully productive life either on or off the job. Noise can destroy hearing, create physical and psychological stress, and thereby contribute to accidents in addition to the obvious cause by making it impossible to hear warning signals. Practical arts and vocational education laboratories and shops are not exempt from noise pollution considerations, particularly if maximization of learning and safety are the goal!



Noise is an unwanted sound. It is a form of energy or vibration that is conducted through the atmosphere. There are four variables that can affect the intensity of noise and its potential danger.

1. The level of the sound, as measured in decibels (dB).
2. The length of time to which one is exposed to the sound.
3. The numbers and lengths of quiet (recovery) periods between periods of sound.
4. Individual sensitivity to or tolerance for sound.

Table 1.1 indicates that workers cannot be exposed to a sound level that exceeds 90dB on the average for an eight-hour day. It should be noted that the standards in this table apply only to work; i.e., day-to-day environments, and schools are typically different. In some cases, however, vocational courses approximate the work situation and, hence, these standards might well apply. Furthermore, it also deserves noting that instructor exposure is often the equivalent of industry despite the fact that student exposure is not. Since hearing is affected by the totality of the noise that one is exposed to, any precautions are appropriate.

Fortunately, noise exposure can be controlled. No matter what noise problems occur in the laboratory and workplace, the technology exists to reduce the hazard. The responsibility to correct noise problems rests on the individuals, i.e., supervisors, teachers, etc., involved. In general, there are three basic ways to control noise.

1. Source Control

The best and most effective approach to control noise is to control it at its source since in this way no further hearing danger is posed and, therefore, other control methods are probably not needed. Techniques of noise source control include:

- a) Reduction of impact noise.
- b) Reduction of the speed of moving and rotating parts.
- c) Reduction of pressures and flow velocities in circulating systems.
- d) Reduction of flow resistance in circulation systems.
- e) Balancing of rotating parts.
- f) Reduction of friction in rotating, sliding, and moving parts.
- g) Isolation of vibration within equipment.
- h) Reduction of the size of the surface radiation areas.
- i) Application of vibration-damping materials to vibrating parts and surfaces.

2. Path Control

If source control is not possible, the next best approach is to control the noise along its path. Although such controls limit the number of persons exposed to the noise, they do not always eliminate the noise problem for all persons affected. In path control, noise is blocked or reduced before it is heard. This can be accomplished by:

- a) Containing or enclosing the noise.
- b) Absorbing the noise along its path.
- c) Deflecting the noise away from our ears.
- d) Separating the noise from the hearer.

3. Hearing Protection

Finally, ear protection equipment is available. This is not as desirable as either source or path control because it affords protection only to those wearing the equipment. Students must be willing to wear hearing protectors whenever they are exposed to potentially dangerous noise. Certain conditions and activities can reduce the effectiveness of the hearing protectors themselves.

Cotton should not be used as protection against abrasive sound. While a wad of cotton may minimize waves of certain frequencies, it fails to alter the intensity thus providing a false sense of security.



TABLE OF NOISE EXPOSURES

HEARING PROTECTION

Cotton should not be used as protection against abrasive sound. While a wad of cotton may minimize waves of certain frequencies, it fails to alter the intensity thus providing a false sense of security.

Sound is measured by two fundamental characteristics: frequency (related to pitch) or number of waves per second and intensity level (related to loudness). The human ear reacts to frequencies ranging from 20 cycles per second to about 20,000. Sound at a level of 85 decibels (db) begins to lead to a loss of hearing, depending on (1) the intensity, (2) the frequency, (3) the duration of exposure, and (4) individual sensitivity. The following are examples of noise and the approximate decibels for each.

Activity	Sound Level (in decibels)
Busy street traffic at about 100 feet	60 db
Office tabulating machines (electric typewriter, etc.)	80 db
20 feet from subway	90 db
Pneumatic diesel shovel (idling	90 db
Diesel shovel (idling	90 db
Automatic screw machines	95 to 105 db
Wire rope stranding machine	102 to 108 db
Header	103 to 108 db
Circular saw	105 to 115 db
Between two compressors	110 db
Drop hammer (depending on size	110 to 135 db
Punch press	112 db
Between two drills, 20 feet apart	117 db
Five feet from pneumatic press	130 db
40 feet from jet engine	138 db

(Source : Washington State Department of Education. (2002). *Safety Guide for Career and Technical Education.*)



XIV. FAMILY & CONSUMER SCIENCE LABORATORY SAFETY SPECIFICATIONS

XIV. FAMILY & CONSUMER SCIENCE LABORATORY SAFETY SPECIFICATIONS

Family and Consumer Sciences Culinary programs prepare students for careers in the industry by using a combination of classroom and hands-on laboratory learning experiences. Culinary classrooms should include industry standard equipment, facilities, and safety practices.

In addition to kitchen facilities, Family and Consumer Sciences Culinary programs are expected to include areas for serving. These areas must be in close proximity to, but separate from, the kitchen facility. All facilities must meet national and state level code(s) and sanitation regulations in regards to the preparation and serving of food.



A. STUDENT SAFETY TRAINING

Students should be knowledgeable about fire safety in the kitchen. They should complete a study of pot fires, range top fires, the fire suppression system for the lab, burns, moving hot items, heat transfer to metal tables, and room evacuation plans. Every student should successfully pass a fire safety competency test before they are allowed to work in the kitchen.

B. FACILITIES

Providing adequate space is an essential component to every safety program. When possible, the following guidelines should be followed to ensure adequate space. The space allocation will differ depending on the type of program and the students involved in the program.

Classroom	25 square feet per student
Kitchen Facility	150 square feet per student
Storage	400 square feet

The number of students in the classroom should be kept to a reasonable limit, as close to 20 students as possible. Keeping the class size small promotes safety as well as adequate instruction for all students.

The facility must be designed so that the instructor has full view of the entire facility at all times. It is important that appropriate utilities be in place including plenty of lighting, water, and adequate electrical outlets throughout the kitchen. Additionally, the facilities should be designed to accommodate the needs of diverse students and adequate ventilation must be provided in these areas.

C. STUDENT DRESS

Student dress is critical to the safe and sanitary operation of the kitchen.

Proper dress includes:

1. Flat heels, closed toe non-slip shoes are worn by staff and students.
2. Loose, flowing extra long sleeves or fur trimmed clothing (including sports jerseys and sweat shirts or “hoodies”) are prohibited.
3. Outdoor clothing is not permitted to be worn.
4. Long pants must be worn by staff and students.
5. Hair must be restrained on top of the head or at the nape of the neck and a hat or hairnet must be worn. In the case of head coverings for religious purposes, a hairnet must be worn to contain the long parts of the head covering
6. Aprons or chef's coats must be worn at all times.



Photo courtesy of Kristine Kirkpatrick



Photo courtesy of Kristine Kirkpatrick

D. STORAGE

It is important to have adequate storage for perishable, frozen, and non-perishable foods. These should all be lockable and separate from storage of supplies and equipment. Additionally, students should have individual lockers separate from the kitchen facility to store personal items.

Lockable storage of knives and sharp equipment should be included as well as lockable storage for expensive items. The care of the knife after use is the responsibility of the user—wash, sanitize, and store. Knives must be stored in a knife kit, on a magnetic strip or in a block when not in use. Knives should not be stored where there is easy access to the classroom door.

Materials used in the Family & Consumer Sciences must adhere to Department of Public Health Food Code and the ServSafe guidelines in regards to chemical storage. Household chemicals should be used on in accordance with manufacturer’s instructions.

(See also Section VI – *General Laboratory Safety Specifications, #17 Chemical Storage*)

APPENDIX A

ADMINISTRATIVE CODE, REGULATION 885

*SAFE MANAGEMENT, STORAGE, AND DISPOSAL OF
CHEMICALS IN THE DELAWARE PUBLIC SCHOOL SYSTEM*

**TITLE 14 EDUCATION
DELAWARE ADMINISTRATIVE CODE****800 Health and Safety****885 Safe Management, Storage, and Disposal of Chemicals in the Delaware Public School System****1.0 Purpose**

The purpose of this regulation is to outline the criteria and processes for Chemical Storage and for Chemical use in the classroom, laboratory, or other Instructional Areas in Delaware public schools. This regulation sets forth the requirements for the safe management, storage, and disposal of chemicals. Additional information may be found in the *Safety First: Safe Instructional Practices in the Classroom and Laboratory* manual.

2.0 Definitions:

The following words and terms, when used in this regulation, shall have the following meaning unless the context clearly states otherwise:

“Carcinogen” means any Chemical that can cause cancer. Included are known or suspected Carcinogens such as formaldehyde, benzene, carbon tetrachloride, nickel salts, sodium dichromate and sodium chromate.

“Chemical” means any element, compound, or mixture of elements and/or compounds.

“Chemical Name” means the scientific designation of a Chemical in accordance with the nomenclature system developed by the International Union of Pure and Applied Chemistry (IUPAC) or the Chemical Abstracts Service (CAS) rules of nomenclature, or a name which will clearly identify the Chemical for the purpose of conducting a hazard evaluation.

“Common Name” means any designation or identification such as a code name, code number, trade name, brand name, or generic name used to identify a Chemical other than its Chemical name.

“Corrosive” means a Chemical that causes visible destruction of or irreversible alterations in, living tissue by Chemical action at the site of contact.

“Explosive” means a Chemical that causes a sudden, almost instantaneous release of pressure, gas, and heat when subjected to sudden shock, pressure, or high temperature.

“Expose or Exposure” means an instance where an individual is subjected to a Hazardous Chemical through any route of entry (inhalation, ingestion, skin contact or absorption, etc.) and includes potential (e.g., accidental or possible) Exposure.

“Hazardous Chemical” means any element, compound or mixture of elements and/or compounds which presents a Physical Hazard or Health Hazard.

“Health Hazard” means a Chemical for which there is statistically significant evidence based on at least one study conducted in accordance with established scientific principles that acute or chronic health effects may occur in exposed employees. The term "Health Hazard" includes Chemicals which are Carcinogens, toxic or highly toxic agents, reproductive toxins, irritants, Corrosives, sensitizers, hepatotoxins, nephrotoxins, neurotoxins, agents which act on the hematopoietic system, and agents which damage the lungs, skin, eyes, or mucous membranes. The Material Safety Data Sheet (MSDS) will provide information to determine whether or not the Chemical is a Health Hazard.

“Instructional Area” means a room or defined space used for an educational activity. An Instructional Area may be a classroom, a laboratory, a field, a special building such as a greenhouse, or any other space where educational activities may take place.

“Long-Term Storage” means the storage of any Chemical for a time period past the end of the school day.

“Material Safety Data Sheet (MSDS)” means a document that contains information on the potential health effects of exposure to Chemicals, or other potentially dangerous substances, and on safe working procedures when handling Chemical products. It contains hazard evaluations on the use, Storage, handling and emergency procedures related to that material. The Material Safety Data Sheet (MSDS) contains much more information about the material than the label and is prepared by the supplier. It is intended to tell what the hazards of the product are, how to use the product safely, what to expect if the recommendations are not followed, what to do if accidents occur, how to recognize symptoms of overexposure, and what to do if such incidents occur.

“Non-hazardous Chemical” means any element, compound or mixture of elements and/or compounds which do not present a Physical Hazard or Health Hazard.

“Occupational Safety and Health Administration (OSHA)” means the government agency in the Department of Labor that develops guidelines to maintain a healthy and safe working environment.

“Physical Hazard” means a Chemical for which there is scientifically valid evidence that it is a combustible liquid, a compressed gas, Explosive, flammable, an organic peroxide, an oxidizer, pyrophoric, unstable (reactive) or water-reactive. The Material Safety Data Sheet (MSDS) will provide information to determine whether or not the Chemical is a Physical Hazard.

“*Safety First: Safe Instructional Practices in the Classroom and Laboratory Manual*” means the collection of documents that outline the mandatory safety procedures regarding the safe management, storage, and disposal of chemicals for Instructional Areas in Delaware public schools and which may be amended from time to time as published in the Delaware Registrar of Regulations. The manual also provides safety practices that are governed by this regulation. This document is available on the Delaware Department of Education Website (www.doe.k12.de.us).

“Short-Term Storage” means the storage of any Chemical for a time period before the end of the school day.

“Storage” means a space for the containment of Chemicals or other materials.

“Surplus Chemical” means any Chemical that is no longer Useable or needed.

“Useable” means that the Chemical or other material has not surpassed its expiration date.

3.0 Applicable Areas

3.1. This regulation is applicable to all public schools, including charter schools and all programs they offer, not already regulated by OSHA standards, including but not limited to science education (including classrooms, laboratories, combination classroom and laboratory settings, and outdoor education settings); Career and Technical Education; Technology and Engineering Education; Agricultural Education; Family and Consumer Science Education, Art Education; and Athletics/Athletic Training.

4.0 Chemical Safety Plan

4.1 All Delaware public schools shall have a Chemical Safety Plan that outlines specific district or charter school procedures in the area of staff and student Chemical safety. The plan shall include at least the following:

- 4.1.1 Identification of at least one Chemical Safety Officer for the district or charter school who shall:
 - 4.1.1.1 Act as liaison between teachers, building and administration, and facilities staff regarding Chemical safety issues;
 - 4.1.1.2 Maintain the Chemical inventory for the school(s);
 - 4.1.1.3 Approve all Chemical orders by the district or charter school,
 - 4.1.1.4 Maintain a supply of Material Safety Data Sheets (MSDS) for all Chemicals in the Chemical inventory;
 - 4.1.1.5 Assist with maintenance requests related to safety equipment; and
 - 4.1.1.6 Identify and coordinate disposal of Hazardous Chemical wastes.
- 4.1.2 Standard operating procedures associated with Chemical use, Chemical Storage, Chemical disposal (both Hazardous and Non-hazardous), and the handling of Chemical spills.

5.0 Inventory of Chemicals, Hazardous and Non-Hazardous

5.1 Each district and charter school shall prepare an inventory of Chemicals by September 15 of each year. A copy of this inventory of Chemicals, along with the respective Material Safety Data Sheet (MSDS), shall be maintained by the school principal, chief custodian, and the Chemical Safety Officer. Additionally, copies shall be maintained in the Chemical Storage area and with the school nurse or school health manager. The inventory of Chemicals, both Hazardous and Non-hazardous, shall contain at least the following information:

- 5.1.1 The name of the Chemical;
- 5.1.2 The amount of the Chemical (in appropriate measurement units);
- 5.1.3 The location where the Chemical is stored; and
- 5.1.4 The date of purchase.

6.0 Chemicals with Special Conditions

- 6.1 Mercury and mercury compounds, both organic and inorganic, shall not be present in or used in public schools in Delaware. Schools may continue to use mercury discharge tubes and fluorescent lights even though they contain a small amount of mercury gas because the mercury is enclosed in the glass container.
- 6.2 Known Carcinogens shall not be present in or used in public schools in Delaware. A listing of known Carcinogens can be found in *Safety First: Safe Instructional Practices in the Classroom and Laboratory*.
- 6.3 All schools shall comply with current Environmental Protection Agency (EPA) regulations regarding regulated refrigerants.

7.0 Storage of Chemicals

- 7.1 The Storage of all Chemicals shall conform to the mandatory specifications stated in *Safety First: Safe Instructional Practices in the Classroom and Laboratory*.
- 7.2 Chemicals in the Instructional Area shall be for immediate use only (Short-Term Storage). All Long-Term Storage of Chemicals shall be in a properly equipped Chemical Storage room.
- 7.3 Pressurized Storage of liquids and gases shall conform to OSHA Storage and handling regulations.

8.0 Management of Chemicals

- 8.1 Instructional staff shall provide training in the safe management of Chemicals to all students in Instructional Areas that use Chemicals annually. All students shall sign a student safety contract at the conclusion of this training. The training shall include at least the following:
 - 8.1.1 An overview of the school safety program;
 - 8.1.2 The location of all Hazardous Chemical containers in the Instructional Area;
 - 8.1.3 An explanation of how to read labels on containers;
 - 8.1.4 The location, availability and content of Material Safety Data Sheets (MSDS) and an explanation of how they are used;
 - 8.1.5 An explanation of the nature of Health Hazards and Physical Hazards associated with the use of all Hazardous Chemicals (regardless of quantity) to which they may be exposed;
 - 8.1.6 An explanation of the proper handling, Storage and disposal methods for each of the Hazardous Chemicals present in the Instructional Area; and
 - 8.1.7 Measures taken by the instructional staff and school personnel to prevent or control Exposure such as engineering controls, personal protective equipment, and emergency procedures for spills or leaks.

9.0 Disposal of Surplus Chemicals

- 9.1 Disposal of Surplus Non-hazardous Chemicals shall be carried out by the school district or charter school in accordance with procedures outlined in the Material Safety Data Sheet (MSDS).
- 9.2 Disposal of Surplus Chemicals, that meet the definition of Hazardous Chemical, shall only be disposed of through the use of a licensed waste hauler.
- 9.2.1 Each district and charter school shall prepare a list of Surplus Hazardous Chemicals and submit it to the Education Associate, Science by November 15 of each year. The Department of Education shall arrange for a licensed waste hauler to take the Chemicals to a proper waste facility for disposal. The cost of disposal shall be prorated among the participating schools. Alternatively, a school district or charter school may independently contract with a licensed waste hauler. An official letter shall be sent to the Education Associate, Science describing the school's intentions and naming the licensed waste hauler.

10.0 Facility Requirements for Instructional Areas that use Hazardous Chemicals

- 10.1 Basic safety equipment shall be installed in all Instructional Areas that use Hazardous Chemicals and shall conform to the requirements outlined in *Safety First: Safe Instructional Practices in the Classroom and Laboratory*. Non-traditional instructional areas such as an outdoor classroom or an agricultural field shall include all of the safety equipment as warranted and deemed necessary based on the hazard level of the lesson and materials being used in the instruction of students. Basic safety equipment shall include at least the following items:
- 10.1.1 Eyewash (running water, continuous flow style)
 - 10.1.2 Acid/Chemical shower (continuous flow style)
 - 10.1.3 Eye protection (wrap-around, splash-shield style goggles)
 - 10.1.4 Fire extinguisher
 - 10.1.5 Fire blanket
 - 10.1.6 Chemical spill equipment
- 10.2 A properly functioning fume hood and/or other industry-standard ventilation system shall be used when mixing Chemicals, using Chemicals, and/or for Short-term Storage of Chemicals that release hazardous fumes. The determination that hazardous fumes may be released is determined by a hazard analysis and a review of the MSDS document(s). Fume hoods and other ventilation systems shall conform to the requirements outlined in *Safety First: Safe Instructional Practices in the Classroom and Laboratory*.
- 10.3 All Instructional Areas that use Hazardous Chemicals which are constructed, reconfigured, or renovated after September 1, 2011 shall provide adequate space for student work at a minimum of 50 square feet per student.
- 10.4 All Instructional Areas that use Hazardous Chemicals shall have at least two means of egress. The second exit may pass through another room and/or a Non-Chemical Storage room if it is used only as an emergency exit.

APPENDIX B

REGULATION 885

ON-SITE COMPLIANCE MONITORING

CHEMICAL STORAGE ROOM & SCIENCE CLASSROOM

CHECKLISTS

Chemical Storage Room Checklist

Date: _____

Evaluator: _____

CHEMICAL STORAGE REQUIREMENT	YES	NO	NA
1. Chemical storerooms are secured areas and must be kept under lock and key with limited access to appropriate staff only. No students are to have access to the chemical storage room at any time.			
2. Chemicals shall not be stored in the classroom for a time period extending beyond the end of the school day. At the end of the day, chemicals are to be secured temporarily in locked storage areas or in the chemical storeroom. All long-term chemical storage must be in a properly equipped chemical storage room.			
3. Chemical storerooms must be properly maintained. Roof leaks, should they occur, must be addressed immediately.			
4. Chemical storerooms are to have appropriate ventilation (non-re-circulating). It is suggested that the room have a minimum of four room exchanges per hour.			
5. Chemical storage rooms must be kept dry and in a temperature range of 50-80 degrees Fahrenheit. Chemicals must not be exposed to direct heat sources, sunlight, or highly variable temperatures.			
6. Chemical storerooms must have a chemical spill center.			
7. Shelving must be made of finished wood or other chemical resistant material with a front lip approximately 0.75 inch (1.9 cm) to 1 inch (2.54 cm) high. All chemical storage shelving and cabinets are to be securely fastened to the wall or floor to prevent tipping over.			
8. Chemicals must be stored using a system that segregates chemicals by hazard levels and/or class (flammable compressed gases, nonflammable compressed gases, flammable liquids, combustible liquids, flammable solids, corrosive acids, corrosive bases, oxidizers, organic peroxides, spontaneously combustible reactives, water reactives, explosives and radioactives).			

<p>9. Chemicals are to be organized by compatibility, not alphabetically. Incompatible chemicals are to be stored separately. For example, acetic acid and acetlehyde (acetaldehyde) could be adjacent neighbors on a shelf and are an incompatible pair. Chemicals should only be stored alphabetically within compatible groups.</p>			
<p>10. All chemicals must have a date of purchase on the container. Older chemicals should be used first and degradation of older chemicals should be monitored.</p>			
<p>11. Flammable liquids must be stored in National Fire Protection Association (NFPA) approved flammable storage containers and cabinets.</p>			
<p>12. Flammable and combustible cabinets should not be directly vented. Venting of these cabinets is not recommended or required except for odor control of malodorous materials. The openings on the bottom and top of the cabinets should be sealed with bungs supplied with the cabinet. If the cabinets are to be vented, vent from the bottom openings and makeup air from the top openings [NFPA 30, 4-3.2].</p>			
<p>13. Chemicals must be separated into organic and inorganic families, and then into compatible and related groups. Compatible groups can be separated by use of different shelves.</p>			
<p>14. Corrosive chemicals such as acids and bases must be stored in separate appropriate chemical storage cabinets.</p>			
<p>15. Nitric acid must be stored in a separate cabinet.</p>			
<p>16. Lithium, potassium and sodium metals are highly discouraged for use in the high school setting and must be stored under dry mineral oil.</p>			
<p>17. All peroxide-forming chemicals (e.g. ethyl ether) must be monitored for age and removed after recommended shelf life.</p>			
<p>18. Hazardous liquids should be stored within a secondary containment.</p>			
<p>19. No chemicals can be stored above eye level or on the floor. Heavy items must be stored on lower shelves only.</p>			

APPENDIX C

LIST OF CARCINOGENS

**NOT PERMITTED FOR USE IN DELAWARE
PUBLIC SCHOOLS**

CARCINOGENS

Carcinogens are compounds or substances that may produce malignant tumors or other forms of cancer upon exposure. They are insidious poisons since their harmful effects are not immediately apparent. Cancers usually do not develop until many months, or even many years after exposure to carcinogenic materials. For this reason, great care should be taken to avoid exposure to any substance expected of being a carcinogen.

In 1974 the Occupational Safety and Health Administration (OSHA) classified 14 chemicals as dangerous carcinogens and issued standards which include specific procedures for working with these chemicals. Later, 6 additional chemicals were added to the list. Subsequently, a number of other compounds were identified by the ACGIH and industrial companies such as Du Pont as being strong carcinogens that pose a very significant health risk.

THESE POTENT CARCINOGENS ARE LISTED IN TABLES I AND II. SINCE THE RISK OF USING THESE COMPOUNDS GREATLY OUTWEIGHS THE POSSIBLE BENEFITS, THE COMPOUNDS IN THESE TABLES MUST NOT BE STORED OR USED IN THE SCHOOL LABORATORIES, AND IF PRESENT, THEY MUST BE REMOVED.

TABLE I
OSHA CARCINOGENS
THESE SUBSTANCES ARE NOT TO BE USED

2-Acetylaminofluorine	1,2-Dibromo-3-chloropropane (DBCP)
Acrylonitrile	4-Aminodiphenyl 3,3'-Dichlorobenzidine (and salts)
Arsenic, inorganic	4-Dimethylaminoazobenzene
Arsenic pentoxide	Ethyleneimine
Arsenic trioxide	Methyl Chloromethyl Ether
Asbestos	alpha-Naphthylene (Naphthylamine)
Benzidine	beta-Naphthylene (Naphthylamine)
Bis(chloromethyl) Ether (and salts)	4-Nitrodiphenyl (aminodiphenyl)
Coal Tar Pitch Volatiles	N-Nitrosodimethylamine
Coke Oven Emissions	beta-Propiolactone
	Sodium Arsenite
	Vinyl Chloride

TABLE II
OTHER CARCINOGENS BELIEVED TO BE SIGNIFICANT HEALTH RISK
AVOID THE USE OF THESE SUBSTANCES

Benz(a)pyrene	4,4'-Methylene Dianiline (and salts)
2,4-Diaminotoluene	Monomethylhydrazine (and salts)
1,4-Dichloro-2-buten	N-(2-Hydroxyethyl)ethyleneimine
Dimethylcarbamoyl Chloride	Nitrosamines
1,1-Dimethylhydrazine (and salts)	2-Nitronaphthalene
Dimethyl Sulfate	Phenyl Glycidyl Ether
2,4-Dinitrotoluene	1,3-Propane Sulfone
Hexamethylphosphoramide	Propyleneimine
Hydrazine (and salts)	2,3,4-Trichloro-1-butene
4,4'-Methylene Bis (2-chloroaniline)	

In addition to the strong carcinogens listed above, (Table I) several hundred other compounds have been screened, usually in animal tests, and found to have weaker carcinogenic properties (Table II). Still others show inconclusive results and are regarded as possible carcinogens.

Some of these "weak" or "possible" carcinogens are common laboratory chemicals, and are likely to be found in high school laboratories. A partial list is included in Table III. Since these compounds present a danger in themselves, and some may eventually be reclassified as "strong" carcinogens, great care should be taken when handling them to avoid ingestion and skin, eye, and respiratory contact.

Remember, the risk increases with both the level and duration of exposure, as well as the potency of the carcinogen. It is prudent to replace any compound suspected of being a carcinogen with a less toxic compound when suitable alternatives are available. For example, benzene can often be replaced by toluene or cyclohexane for solvent use, and ethyl acetate can be used instead of carbon tetrachloride for insect killing jars.

TABLE III
SUSPECTED AND/OR WEAK CARCINOGENS
AVOID USING THESE SUBSTANCES
OR
USE WITH EXTREME CARE AND CONTROLLED EXPOSURE

Acetamide	p-Dioxane
Anthracene	Ethyl Carbamate (Urethane)
Aniline (and salts)	Ethylene Oxide
*Benzene	* Formaldehyde
Beryllium Carbonate	* Lead (IV) Chromate
Cadmium (and salts)	* Lead Diacetate
*Carbon Tetrachloride	Methyl Iodide
*Chloroform	* Nickel (and Acetate, Carbonate, Oxide)
*Chromium (and III, VI Oxide, Acetate, Nitrate)	
Sudan IV	
Cobalt	Tannic Acid
Colchicine	Thioacetamide
1,2-Dichloroethane (Ethylene chloride)	Thiourea
	o-Toluidine

** Commonly found in school laboratories.*

Most of the substances that have undergone formal risk assessment are industrial chemicals. Many chemicals used only in the laboratory have never been tested for their human carcinogenic potential. Indeed some may be very potent carcinogens.

Particularly suspect are the strong alkylating agents such as esters of strong acids and reactive organic halides.

APPENDIX D

LIST OF EXTREMELY DANGEROUS CHEMICALS

LIST OF EXTREMELY HAZARDOUS SUBSTANCES AND THEIR THRESHOLD PLANNING QUANTITIES

THE FOLLOWING SUBSTANCES ARE CONSIDERED EXTREMELY HAZARDOUS CHEMICALS. EXTREME CARE SHOULD BE USED WITH THESE SUBSTANCES. THE LIST IS NOT ALL-INCLUSIVE; OTHER HAZARDOUS CHEMICALS NOT ON THIS LIST MAY POSE A HIGH LEVEL OF RISK ASSOCIATED WITH THEIR STORAGE AND USE.

CAS #	Chemical Name (in alpha order)	Notes	RQ TPQ
=====	=====	===	=====
75.86.5	Acetone Cyanohydrin		10 1000
1752.30.3	Acetone Thiosemicarbazide	e	1 1000/10000
107.02.8	Acrolein		1 500
79.06.1	Acrylamide	d,l	5000 1000/10000
107.13.1	Acrylonitrile	d,l	100 10000
814.68.6	Acrylyl Chloride	e,h	1 100
111.69.3	Adiponitrile	e,l	1 1000
116.06.3	Aldicarb	c	1 100/10000
309.00.2	Aldrin	d	1 500/10000
107.18.6	Allyl Alcohol		100 1000
107.11.9	Allylamine	e	1 500
20859.73.8	Aluminum Phosphide	b	100 500
54.62.6	Aminopterin	e	1 500/10000
78.53.5	Amiton	e	1 500
3734.97.2	Amiton Oxalate	e	1 100/10000
7664.41.7	Ammonia	l	100 500
300.62.9	Amphetamine	e	1 1000
62.53.3	Aniline	d,l	5000 1000
88.05.1	Aniline, 2,4,6-trimethyl-	e	1 500
7783.70.2	Antimony Pentafluoride	e	1 500
1397.94.0	Antimycin A	c,e	1 1000/10000
86.88.4	ANTU		100 500/10000
1303.28.2	Arsenic Pentoxide	d	5000 100/10000
1327.53.3	Arsenous Oxide	d,h	5000 100/10000
7784.34.1	Arsenous Trichloride	d	5000 500
7784.42.1	Arsine	e	1 100
2642.71.9	Azinphos-Ethyl	e	1 100/10000
86.50.0	Azinphos-Methyl		1 10/10000
98.87.3	Benzal Chloride	d	5000 500
98.16.8	Benzenamine, 3-(Trifluoromethyl)-	e	1 500
100.14.1	Benzene, 1-(Chloromethyl)-4-Nitro	e	1 500/10000
98.05.5	Benzeneearsonic Acid	e	1 10/10000
3615.21.2	Benzimidazole, 4,5-Dichloro-2-(Trifluoromethyl)-	e,g	1 500/10000
98.07.7	Benzotrichloride	d	1 100
100.44.7	Benzyl Chloride	d	100 500
140.29. 4	Benzyl Cyanide	e,h	1 500
15271.41.7	Bicyclo[2,2,1] Heptane-2-Carbonitrile, 5-Chloro-6-	e	1 500/10000
534.07.6	Bis (Chloromethyl) Ketone	e	1 10/10000
4044.65.9	Bitoscanate	e	1 500/10000
10294.34.5	Boron Trichloride	e	1 500
7637.07.2	Boron Trifluoride	e	1 500
353.42.4	Boron Trifluoride with Methyl Ether (1:1)	e	1 1000

28772.56.7	Bromadiolone	e	1 100/10000
7726.95.6	Bromine	e,l	1 500
1306.19.0	Cadmium Oxide	e	1 100/10000
2223.93.0	Cadmium Stearate	c,e	1 1000/10000
7778.44.1	Calcium Arsenate	d	1000 500/10000
8001.35.2	Camphchlor	d	1 500/10000
56.25.7	Cantharidin	e	1 100/10000
51.83.2	Carbachol Chloride	e	1 500/10000
1563.66.2	Carbofuran		10 10/10000
75.15.0	Carbon Disulfide	l	100 10000
786.19.6	Carbophenothion	e	1 500
57.74.9	Chlordane	d	1 1000
470.90.6	Chlorfenvinfos	e	1 500
7782.50.5	Chlorine		10 100
24934.91.6	Chlormepfos	e	1 500
999.81.5	Chlormequat Chloride	e,h	1 100/10000
79.11.8	Chloroacetic Acid	e	1 100/10000
107.07.3	Chloroethanol	e	1 500
627.11.2	Chloroethyl Chloroformate	e	1 1000
67.66.3	Chloroform	d,l	5000 100 00
542.88.1	Chloromethyl Ether	d,h	1 100
107.30.2	Chloromethyl Methyl Ether	c,d	1 100
3691.35.8	Chlorophacinone	e	1 100/10000
1982.47.4	Chloroxuron	e	1 500/10000
21923.23.9	Chlorthiophos	e,h	1 500
10025.73.7	Chromic Chloride	e	1 1/1000
10210.68.1	Cobalt Carbonyl	e,h	1 10/10000
64.86.8	Colchicine	e,h	1 10/10000
56.72.4	Coumaphos		10 100/10000
5836.29.3	Coumatetralyl	e	1 500/10000
95.48.7	Cresol, o-	d	10001000/10000
535.89.7	Crimidine	e	1 100/10000
4170.30.3	Crotonaldehyde		100 1000
123.73.9	Crotonaldehyde, (E)-		100 1000
506.68.3	Cyanogen Bromide		1000 500/10000
506.78.5	Cyanogen Iodide	e	1 1000/10000
2636.26.2	Cyanophos	e	1 1000
675.14.9	Cyanuric Fluoride	e	1 100
66.81.9	Cycloheximide	e	1 100/10000
108.91.8	Cyclohexylamine	e,l	1 10000
17702.41.9	Decaborane(14)	e	1 500/10000
8065.48.3	Demeton	e	1 500
919.86.8	Demeton-S-Methyl	e	1 500
10311.84.9	Dialifor	e	1 100/10000
19287.45.7	Diborane	e	1 100
111.44.4	Dichloroethyl Ether	d	1 10000
149.74.6	Dichloromethylphenylsilane	e	1 1000
62.73.7	Dichlorvos		10 1000
141.66.2	Dicrotophos	e	1 100
1464.62.6	Diepoxybutane	d	1 500
814.49.3	Diethyl Chlorophosphate	e,h	1 500
1642.54.2	Diethylcarbamazine Citrate	e	1 100/10000
71.63.6	Digitoxin	c,e	1 100/10000
2238.07.5	Diglycidyl Ether	e	1 1000
20830.75.5	Digoxin	e,h	1 10/10000
115.26.4	Dimefox	e	1 500

60.51.5	Dimethoate		10 500/10000
2524.03.0	Dimethyl Phosphorochloridothioate	e	1 500
77.78.1	Dimethyl Sulfate	d	1 500
75.18.3	Dimethyl Sulfide	e	1 100
75.78.5	Dimethyldichlorosilane	e,h	1 500
57.14.7	Dimethylhydrazine	e	1 1000
99.98.9	Dimethyl-p-Phenylenediamine	e	1 10/10000
644.64.4	Dimetilan		1 500/10000
534.52.1	Dinitrocresol		10 10/10000
88.85.7	Dinoseb		1000100/10000
1420.07.1	Dinoterb	e	1 500/10000
78.34.2	Dioxathion	e	1 500
82.66.6	Diphacinone	e	1 10/10000
152.16.9	Diphosphoramidate, Octamethyl-		100 100
298.04.4	Disulfoton		1 500
514.73.8	Dithiazanine Iodide	e	1 500/10000
541.53.7	Dithiobiuret		100 100/10000
316.42.7	Emetine, Dihydrochloride	e,h	1 1/10000
115.29.7	Endosulfan		1 10/10000
2778.04.3	Endothion	e	1 500/10000
72.20.8	Endrin		1 500/10000
106.89.8	Epichlorohydrin	d,l	1000 1000
2104.64.5	EPN	e	1 100/10000
50.14.6	Ergocalciferol	c,e	1 1000/10000
379.79.3	Ergotamine Tartrate	e	1 500/10000
1622.32.8	Ethanesulfonyl Chloride, 2-Chloro-	e	1 500
10140.87.1	Ethanol, 1,2-Dichloro-, Acetate	e	1 1000
563.12.2	Ethion		10 1000
13194.48.4	Ethoprophos	e	1 1000
538.07.8	Ethylbis(2-Chloroethyl)Amine	e,h	1 500
371.62.0	Ethylene Fluorohydrin	c,e,h	1 10
75.21.8	Ethylene Oxide	d,l	1 1000
107.15.3	Ethylenediamine		5000 10000
151.56.4	Ethyleneimine	d	1 5000
542.90.5	Ethylthiocyanate	e	1 10000
22224.92.6	Fenamiphos	e	1 10/10000
122.14.5	Fenitrothion	e	1 500
115.90.2	Fensulfothion	e,h	1 500
4301.50.2	Fluenetil	e	1 100/10000
7782.41.4	Fluorine	k	10 500
640.19.7	Fluoroacetamide	j	100 100/10000
144.49.0	Fluoroacetic Acid	e	1 10/10000
359.06.8	Fluoroacetyl Chloride	c,e	1 10
51.21.8	Fluorouracil	e	1 500/10000
944.22.9	Fonofos	e	1 500
500.00.0	Formaldehyde	d,l	1000 500
107.16.4	Formaldehyde Cyanohydrin	e,h	1 1000
23422.53.9	Formetanate Hydrochloride	e,h	1 500/10000
2540.82.1	Formothion	e	1 100
17702.57.7	Formparanate	e	1 100/10000
21548.32.3	Fosthietan	e	1 500
3878.19.1	Fuberidazole	e	1 100/10000
110.00.9	Furan		100 500
13450.90.3	Gallium Trichloride	e	1 500/10000
77.47.4	Hexachlorocyclopentadiene	d,h	1 100
4835.11.4	Hexamethylenediamine, N,N-Dibutyl-	e	1 500

302.01.2	Hydrazine	d	1 1000
74.90.8	Hydrocyanic Acid		10 100
7647.01.0	Hydrogen Chloride (gas only)	e,l	1 500
7664.39.3	Hydrogen Fluoride		100 100
7722.84.1	Hydrogen Peroxide (conc > 52%)	e,l	1 1000
7783.07.5	Hydrogen Selenide	e	1 10
7783.06.4	Hydrogen Sulfide	l	100 500
123.31.9	Hydroquinone	e	1 500/10000
13463.40.6	Iron, Pentacarbonyl-	e	1 100
297.78.9	Isobenzan	e	1 100/10000
78.82.0	Isobutyronitrile	e,h	1 1000
102.36.3	Isocyanic Acid, 3,4,-Dichlorophenyl Ester	e	1 500/10000
465.73.6	Isodrin	l	100/10000
55.91.4	Isofluorophate	c	100 100
4098.71.9	Isophorone Diisocyanate	b,e	1 100
108.23.6	Isopropyl Chloroformate	e	1 1000
625.55.8	Isopropyl Formate	e	1 500
119.38.0	Isopropylmethylpyrazolyl Dimethylcarbamate	e	1 500
78.97.7	Lactonitrile	e	1 1000
21609.90.5	Leptophos	e	1 500/10000
541.25.3	Lewisite	c,e,h	1 10
58.89.9	Lindane	d	1 1000/10000
7580.67.8	Lithium Hydride	b,e	1 100
109.77.3	Malononitrile		100500/10000
12108.13.3	Manganese, Tricarbonyl Methylcyclopentadienyl	e,h	1 100
51.75.2	Mechlorethamine	c,e	1 10
950.10.7	Mephosfolan	e	1 500
1600.27.7	Mercuric Acetate	e	1 500/10000
7487.94.7	Mercuric Chloride	e	1 500/10000
21908.53.2	Mercuric Oxide	e	1 500/10000
10476.95.6	Methacrolein Diacetate	e	1 1000
760.93.0	Methacrylic Anhydride	e	1 500
126.98.7	Methacrylonitrile	h	1 500
920.46.7	Methacryloyl Chloride	e	1 100
30674.80.7	Methacryloyloxethyl Isocyanate	e,h	1 100
10265.92.6	Methamidophos	e	1 100/100005
58.25.8	Methanesulfonyl Fluoride	e	1 1000
950.37.8	Methidathion	e	1 500/10000
2032.65.7	Methiocarb		10 500/10000
16752.77.5	Methomyl	h	100 500/10000
151.38.2	Methoxyethylmercuric Acetate	e	1 500/10000
90.63.7	Methyl 2-Chloroacrylate	e	1 500
74.83.9	Methyl Bromide	l	1000 1000
79.22.1	Methyl Chloroformate	d,h	1000 500
624.92.0	Methyl Disulfide	e	1 100
60.34.4	Methyl Hydrazine		10 500
624.83.9	Methyl Isocyanate	f	1 5005
56.61.6	Methyl Isothiocyanate	b,e	1 500
74.93.1	Methyl Mercaptan		100 500
3735.23.7	Methyl Phenkapton	e	1 500
676.97.1	Methyl Phosphonic Dichloride	b,e	1 100
556.64.9	Methyl Thiocyanate	e	1 10000
78.94.4	Methyl Vinyl Ketone	e	1 10
502.39.6	Methylmercuric Dicyanamide	e	1 500/10000

75.79.6	Methyltrichlorosilane	e,h	1 500
1129.41.5	Metolcarb	e	1 100/10000
7786.34.7	Mevinphos		10 500
315.18.4	Mexacarbate		1000 500/10000
50.07.7	Mitomycin C	d	1 500/10000
6923.22.4	Monocrotophos	e	1 10/10000
2763.96.4	Muscimol	e,h	1000 10000
505.60.2	Mustard Gas	e,h	1 500
13463.39.3	Nickel Carbonyl	d	1
154.11.5	Nicotine	c	100 100
65.30.5	Nicotine Sulfate	e	1 100/10000
7697.37.2	Nitric Acid		1000 1000
10102.43.9	Nitric Oxide	c	10 100
98.95.3	Nitrobenzene	l	1000 10000
1122.60.7	Nitrocyclohexane	e	1 500
10102.44.0	Nitrogen Dioxide		10 100
62.75.9	Nitrosodimethylamine	d,h	1 1000
991.42.43	Norbormide	e	1 100/10000
0	Organorhodium Complex (PMN.82.147)	e	1 10/10000
630.60.4	Ouabain	c,e	1 100/10000
23135.22.0	Oxamyl	e	1 100/10000
78.71.7	Oxetane, 3,3 -Bis(Chloromethyl)-	e	1 500
2497.07.6	Oxydisulfoton	e,h	1 500
10028.15.6	Ozone	e	1 100
1910.42.5	Paraquat	e	1 10/10000
2074.50.2	Paraquat Methosulfate	e	1 10/10000
56.38.2	Parathion	c,d	1 1000
298.00.0	Parathion-Methyl	c	100100/10000
12002.03.8	Paris Green	d	100500/10000
19624.22.7	Pentaborane	e	1 500
2570.26.5	Pentadecylamine	e	1 100/10000
79.21.0	Peracetic Acid	e	1 500
594.42.3	Perchloromethylmercaptan		100 500
108.95.2	Phenol		1000 500/10000
97.18.7	Phenol, 2,2 -Thiobis(4,6 -Dichloro)-	e	1 100/10000
4418.66.0	Phenol, 2,2 -Thiobis(4-Chloro-6-Methyl)-	e	1 100/10000
64.00.6	Phenol, 3 - (1-Methylethyl)-, Methylcarbamate	e	1 500/10000
96.28.6	Phenyl Dichloroarsine	d,h	1 500
59.88.1	Phenylhydrazine Hydrochloride	e	1 1000/10000
62.38.4	Phenylmercury Acetate		100 500/10000
2097.19.0	Phenylsilatrane	e,h	1 100/10000
103.85.5	Phenylthiourea		100 100/10000
298.02.2	Phorate		10 10
4104.14.7	Phosacetim	e	1 100/10000
947.02.4	Phosfolan	e	1 100/10000
75.44.5	Phosgene	l	10 10
732.11.6	Phosmet	e	1 10/10000
13171.21.6	Phosphamidon	e	1 100
7803.51.2	Phosphine		100 500
2703.13.1	Phosphonothioic Acid,Methyl-O-Ethyl, O-(4-(Methylthio Phenyl) Ester	e	1 500
50782.69.9	Phosphonothioic Acid, Methyl-S(2-(Bis (1-Methylethyl) Amino)Ethyl)	e	1 100

2665.30.7	Phosphonothioic Acid, Methyl-O-(4-Nitrophenyl) O-Phenyl Ester	e	1 500
3254.63.5	Phosphoric Acid, Dimethyl 4-(Methylthio) Phenyl Ester	e	1 500
2587.90.8	Phosphorothioic Acid, O,O-Dimethyl-S-(2-Methylthio) Ethyl Ester	c,e,g	1 500
7723.14.0	Phosphorus	b,h	1 100
10025.87.3	Phosphorus Oxychloride	d	1000 500
10026.13.8	Phosphorus Pentachloride	b,e	1 500
1314.56.63	Phosphorus Pentoxide	b,e	1 10
7719.12.2	Phosphorus Trichloride		1000 1000
57.47.6	Physostigmine	e	1 100/10000
57.64.7	Physostigmine, Salicylate (1:1)	e	1 100/10000
124.87.8	Picrotoxin	e	1 500/10000
110.89.4	Piperidine	e	1 1000
5281.13.0	Piprotal	e	1 100/10000
23505.41.1	Pirimifos-Ethyl	e	1 100
10124.50.2	Potassium Arsenite	d	1000 500/10000
151.50.8	Potassium Cyanide	b	10 100
506.61. 6	Potassium Silver Cyanide	b	1 500
2631.37.0	Promecarb	e,h	1 500/10000
106.96.7	Propargyl Bromide	e	1 10
57.57.8	Propiolactone, Beta-	e	1 500
107.12.0	Propionitrile		10 500
542.76.7	Propionitrile, 3-Chloro-		1000 1000
70.69.9	Propiophenone, 4-Amino-	e,g	1 100/10000
109.61.5	Propyl Chloroformate	e	1 500
75.56.9	Propylene Oxide	l	100 10000
75.55.8	Propyleneimine	d	1 10000
2275.18.5	Prothoate	e	1 100/10000
129.00.0	Pyrene	c	50001000/10000
140.76.1	Pyridine, 2-Methyl-5-Vinyl-	e	1 500
504.15.5	Pyridine, 4-Amino-	h	1000500/10000
1124.33.0	Pyridine, 4-Nitro-, 1-Oxide	e	1 500/10000
53558.25.1	Pyriminil	e,h	1 100/10000
14167.18.1	Salcomine	e	1 500/10000
107.44.8	Sarin	e,h	1 10
7783.00.8	Selenious Acid		10 1000/10000
7791.23.3	Selenium Oxychloride	e	1 500
563.41.7	Semicarbazide Hydrochloride	e	1 1000/10000
3037.72.7	Silane, (4-Aminobutyl)Diethoxymethyl-	e	1 1000
7631.89.2	Sodium Arsenate	d	1001000/10000
7784.46.5	Sodium Arsenite	d	10500/10000
26628.22.78	Sodium Azide (NaN ₃)	b	1000 500
124.65.2	Sodium Cacodylate	e	1 100/10000
143.33.9	Sodium Cyanide (NaCN)	b	10 100
62.74.8	Sodium Fluorophenate		10 10/10000
131.52.2	Sodium Pentachlorophenate	e	1 100/10000
13410.01.0	Sodium Selenate	e	1 100/10000
10102.18.8	Sodium Selenite	h	100100/10000
10102.20.2	Sodium Tellurite	e	1 500/10000
900.95.8	Stannane, Acetoxytriphenyl-	e,g	1 500/10000
57.24.9	Strychnine	c	10 100/10000
60.41.3	Strychnine, Sulfate	e	1 100/10000

3689.24.5	Sulfotep		100 500
3569.57.1	Sulfoxide, 2-Chloropropyl Octyl	e	1 500
7446.09.5	Sulfur Dioxide	e,l	1 500
7783.60.0	Sulfur Tetrafluoride	e	1 100
7446.11.9	Sulfur Trioxide	b,e	1 100
7664.93.9	Sulfuric Acid		1000 10000
77.81.6	Tabun	c,e,h	1 10
13494.80.9	Tellurium	e	1 500/10000
7783.80.4	Tellurium Hexafluoride	e,k	1 100
107.49.3	TEPP		10 100
13071.79.9	Terbufos	e,h	1 100
78.00.2	Tetraethyllead	c,d	10 100
597.64.8	Tetraethyltin	c,e	1 100
75.74.1	Tetramethyllead	c,e,l	1 100
509.14.8	Tetranitromethane		10 500
10031.59.1	Thallium Sulfate	j	100 100/10000
6233.73.9	Thallos Carbonate	c,h	100 100/10000
7791.12.0	Thallos Chloride	c,h	100 100/10000
2757.18.8	Thallos Malonate	c,e,h	1 100/10000
7446.18.6	Thallos Sulfate		100 100/10000
2231.57.4	Thiocarbazide	e	1 1000/10000
39196.18.4	Thiofanox		100 100/10000
297.9702	Thionazin		100 500
108.98.5	Thiophenol		100 500
79.1936	Thiosemicarbazide		100 100/10000
5344.82.1	Thiourea, (2-Chlorophynyl)-		100 100/10000
614.78.8	Thiourea, (2-Methylphynyl)-	e	1 500/10000
7550.45.0	Titanium Tetrachloride	e	1 100
584.84.9	Toluene 2,4-Diisocyanate		100 500
91.08.7	Toluene 2,6-Diisocyanate		100 100
110.57.6	Trans-1,4-Dichlorobutene	e	1 500
1031.47.6	Triamiphos	e	1 500/10000
24017.47.8	Triazofos	e	1 500
76.02.8	Trichloroacetyl Chloride	e	1 500
115.21.9	Trichloroethylsilane	e,h	1 500
327.98.0	Trichloronate	e,k	1 500
98.13.5	Trichlorophenylsilane	e,h	1 500
1558.25.4	Trichloro(Chloromethyl)Silane	e	1 100
27137.85.5	Trichloro(Dichlorophenyl)Silane	e	1 500
998.30.1	Triethoxysilane	e	1 500
75.77.4	Trimethylchlorosilane	e	1 1000
824.11.3	Trimethylpropane Phosphite	e,h	1 100/10000
1066.45.1	Trimethyltin Chloride	e	1 500/10000
639.58.7	Triphenyltin Chloride	e	1 500/10000
555.77.1	Tris(2-Chloroethyl)Amine	e,h	1 100
2001.95.8	Valinomycin	c,e	1 1000/10000
1314.62.4	Vanadium Pentoxide		1000 100/10000
108.05.4	Vinyl Acetate Monomer	d,l	5000 1000
81.81.2	Warfarin		100 500/10000
129.06.6	Warfarin Sodium	e,h	1 100/10000
28347.13.9	Xylylene Dichloride	e	1 100/10000
58270.08.9	Zinc, Dichloro(4,4-Dimethyl-5((Methylamino)Carbonyl)Oxy)Imino)Pentanenitrile)-,(T-4)-	e	1 100/10000
1314.84.7	Zinc Phosphide	b	100 500

*** NOTES ***

RQ Reportable Quantity (in pounds)

TPQ Threshold Planning Quantity (in pounds)

- a* Only the statutory or final RQ is shown. For more information, see 40CFR Table 302.4
- b This material is a reactive solid. The TPQ does not default to 10,000 pounds for non-powder, non-molten, non-solution form.
- c The calculated TPQ changed after technical review as described in the technical support document.
- d Indicates the RQ is subject to change when the assessment of potential carcinogenicity and/or other toxicity is completed.
- e Statutory reportable quantity for purposes of notification under SARA sect 304(a)(2)
- f The statutory 1 pound reportable quantity for methylisocyanate may be adjusted in a future rule-making action.
- g New chemicals added that were not part of the original list of 402 substances.
- h Revised TPQ based on new or re-evaluated toxicity data.
- j TPQ is revised to its calculated value and does not change due to technical review as in proposed rule.
- k The TPQ was revised after proposal due to calculation error.
- l Chemicals on the original list that do not meet the toxicity criteria but because of their high production volume and recognized toxicity are considered chemicals of concern ("Other Chemicals")

APPENDIX E

LIST OF APPROVED CHEMICAL WASTE HAULERS BY THE DELAWARE DEPARTMENT OF EDUCATION

Delaware Department of Education

Approved Chemical Waste Haulers



Contact: Gary Founds
Phone 610-436-4749
Fax 610-430-6948
www.eldredgeco.com

Address: Eldredge Co.
898 Fernhill Rd.
West Chester, PA 19380-4256



Contact: Ann Smith
C: 856-266-0030
V: 610-518-5800
F: 610-518-0500

Address: *US Environmental*
Environmental Specialist
409 Boot Road
Downingtown, PA 19335

APPENDIX F

CHEMICAL STORAGE

COMPATIBILITY COLOR CODING SYSTEM

Chemical Storage Compatibility Color Coding System

Red	Flammables
Yellow	Oxidizers
White	Corrosives
Blue	Poisons
Green	General Storage

The five color coded system is an industry standard. Chemicals can be characterized into 5 different groups based on their main hazard. The five groups are green (general storage), blue (poisons), red (flammables), yellow (oxidizers), and white (corrosives). It is recommended that these groups of chemicals be stored separately. To aid in this process, many manufacturers have started shipping chemicals with a color coded label. Recently, some companies have begun shipping chemicals out with the caps following these colors to aid in the organization process. This storage system prevents the hazards that can occur in a storage room. For example, the flammables are away from the oxidizers (this one is very important). If oxidizers and flammables come in contact you get fire. Also, it separates the acids and bases (corrosives) which must be stored in a separate acid/corrosive cabinet.

APPENDIX G

STORAGE OF PRESSURIZED LIQUIDS AND GASES

STORAGE OF PRESSURIZED LIQUIDS AND GASES

Pressurized liquids and gasses must be stored and handled according to current OSHA regulations. Storage bottles must be kept to a small “lecture size” container unless the equipment demands a large tank size (gas chromatograph, MIG welder, etc.). In most cases, a small bottle is adequate.

Lecture size bottles:



Gas Chromatograph Machine with Helium bottle

APPENDIX H

SAMPLE CHEMICAL INVENTORY FORM

Chemical Inventory Sheet

Location: Science Coalition School, Chemical Storage Room 314

District: Delaware DOE School District

Signature: *Joe Safety*

Date: February 30, 2011

Chemical Name	Amount	Date of Purchase	Location	MSDS	Hazard Level
Assorted food coloring	22 bottles	>2010	Shelf	Y	Green
Confectioners' sugar	453 g	>2010	Shelf	Y	Green
Effervescent tablets	72 tablets	>2010	Shelf	Y	Green
Gelatine packets	226 g	>2010	Shelf	N	Green
Glucose test strips	1 pkg	>2010	Shelf	N	Green
Karo syrup	1000 g	2010	Shelf	N	Green
KoolAid mix	538 g	>2010	Shelf	N	Green
Lemonade mix	538 g	>2010	Shelf	N	Green
Liquid Starch (Sta-Flo)	3000 ml	>2010	Shelf	Y	Green
Aluminum Chloride	250 g	>2010	Inorganic Cabinet	Y	Green
Ammonium Thiocyanate	1000g	>2010	Inorganic Cabinet	Y	Blue
Barium Chloride	500 g	1985	Inorganic Cabinet	Y	Green
Barium Hydroxide	1500 g	>2010	Inorganic Cabinet	Y	Blue
Calcium Hydroxide	100 g	2010	Inorganic Cabinet	Y	White
Calcium Nitrate	500 g	1999	Inorganic Cabinet	Y	Yellow
Calcium Sulfate	100 g	2000	Inorganic Cabinet	Y	Green
Agar	1240 g	>2010	Organic Cabinet	Y	Green
Glycine	1800 g	>2010	Organic Cabinet	Y	Blue
Lactose	500 g	>2010	Organic Cabinet	Y	Green

Delaware DOE School District

Page 1

Acetic Acid (.01 M)	500 ml	>2010	Acid Cabinet	Y	White
Acetic Acid (.1 M)	200 ml	2001	Acid Cabinet	Y	White
Citric Acid	2000 g	>2010	Acid Cabinet	Y	White
Hydrochloric Acid (.1M)	400 ml	2010	Acid Cabinet	Y	White
Hydrochloric Acid (1 M)	600 ml	2010	Acid Cabinet	Y	White
Hydrochloric Acid (3 M)	2100 ml	2010	Acid Cabinet	Y	White
Vinegar	50 ml	2010	Acid Cabinet	Y	Green
Ammonium Hydroxide (17.4M)	512ml	>2010	Corrosives Cabinet	Y	Red
Barium Hydroxide	250ml	>2010	Corrosives Cabinet	Y	Blue
Calcium Hydroxide	1500 g	>2010	Corrosives Cabinet	Y	Green
Sodium Hydroxide (1M)	1000ml	>2010	Corrosives Cabinet	Y	Blue
Sodium Hydroxide (3M)	1000ml	>2010	Corrosives Cabinet	Y	Blue
Acetone	200ml	2004	Flammables Cabinet 1	Y	Red
Ethyl/Alcohol	4030ml	>2010	Flammables Cabinet 1	Y	Red
Isopropyl/Alcohol	30,000ml	>2010	Flammables Cabinet 1	Y	Red
Color Coding System					
Flammables	Red				
Oxidizers	Yellow				
Corrosives	White				
Poisons	Blue				
General Storage	Green				

APPENDIX I

THE NATIONAL FIRE PROTECTION ASSOCIATION (NFPA) DIAMOND & HAZARD RATING SYSTEM

The National Fire Protection Association (NFPA) Diamond and Hazard Rating System

NFPA 704 is a standard maintained by the [U.S.-based National Fire Protection Association](#). It defines the colloquial "**fire diamond**" used by emergency personnel to quickly and easily identify the risks posed by nearby hazardous materials and/or areas. This is necessary to help determine what, if any, special equipment should be used, procedures followed, or precautions taken during the first moments of an emergency response.



- The NFPA fire diamond is typically displayed on doors, walls, and/or materials that present a safety hazard or entrance into an area where safety hazards are present. The four divisions of the fire diamond are color-coded. Blue indicates the level of [health hazard](#), red indicates the level of [flammability hazard](#), yellow indicates the level of (chemical) [reactivity hazard](#), and the white section contains a special code for unique hazards.
- Each of the health, flammability and reactivity sections are rated on a scale from 0 (no hazard; normal substance) to 4 (severe risk).



Health (Blue)	
0	Poses no health hazard, no precautions necessary (e.g., water)
1	Exposure would cause irritation with only minor residual injury (e.g., acetone)
2	Intense or continued but not chronic exposure could cause temporary incapacitation or possible residual injury (e.g., ethyl ether)
3	Short exposure could cause serious temporary or moderate residual injury (e.g., chlorine gas)
4	Very short exposure could cause death or major residual injury (e.g., hydrogen cyanide, phosphine, carbon monoxide)
Instability/Reactivity (Yellow)	
0	Normally stable, even under fire exposure conditions, and is not reactive with water (e.g. helium)
1	Normally stable, but can become unstable at elevated temperatures and pressures (e.g. propene)
2	Undergoes violent chemical change at elevated temperatures and pressures, reacts violently with water, or may form explosive mixtures with water (e.g., phosphorus, potassium, sodium)
3	Capable of detonation or explosive decomposition but requires a strong initiating source, must be heated under confinement before initiation, reacts explosively with water, or will detonate if severely shocked (e.g. ammonium nitrate)
4	Readily capable of detonation or explosive decomposition at normal temperatures and pressures (e.g., nitroglycerine, Trinitrotoluene)
Flammability (Red)	
0	Will not burn (e.g., argon)
1	Must be heated before ignition can occur (e.g., mineral oil). Flash point over 93°C (200°F)
2	Must be moderately heated or exposed to relatively high ambient temperature before ignition can occur (e.g., diesel fuel). Flash point between 38°C (100°F) and 93°C (200°F)
3	Liquids and solids that can be ignited under almost all ambient temperature conditions (e.g., gasoline). Liquids having a Flash point below 23°C (73°F) and having a Boiling point at or above 38°C (100°F) or having a Flash point between 23°C (73°F) and 38°C (100°F)
4	Will rapidly or completely vaporize at normal atmospheric pressure and temperature, or is readily dispersed in air and will burn readily (e.g., propane). Flash point below 23°C (73°F)
Special (White)	
	The white "special notice" area can contain several symbols. The following symbols are defined by the NFPA 704 standard.
OX	Oxidizer (e.g., potassium perchlorate, ammonium nitrate, hydrogen peroxide)
W	Reacts with water in an unusual or dangerous manner (e.g., cesium, sodium, sulfuric acid)

Non-Standard Symbols

Note: These hazard symbols are not part of the NFPA 704 standard, but are occasionally used in an unofficial manner. The use of non-standard symbols or text may be permitted, required or disallowed by the authority having jurisdiction (e.g., fire department).

- COR: Corrosive; strong acid or base (e.g. sulfuric acid, potassium hydroxide)
 - ACID and ALK to be more specific
- BIO or : Biological hazard (e.g., smallpox virus)
- POI: Poisonous (e.g. Strychnine)
- : Radioactive (e.g., plutonium, uranium)
- CYL or CRYO: Cryogenic (e.g. Liquid Nitrogen)

APPENDIX J

LABELS FOR NON-CHEMICAL REFRIGERATORS

NOTICE

**FOR CHEMICAL
STORAGE ONLY
NO FOOD
PERMITTED**

NOTICE

**FOR CHEMICAL
STORAGE ONLY
NO FOOD
PERMITTED**

APPENDIX K

BIOHAZARD SIGN



